

UNIVERSIDAD SAN FRANCISCO DE QUITO USFQ

Colegio de Posgrados

ELECTRONICS SYSTEM ENGINEERING Flat-Sat for IGOSat

JUAN ANDRES VALVERDE JARA

Julien Perchoux, Ph.D.

Trabajo de titulación de posgrado presentado como requisito
para la obtención del título de Magíster en Nanoelectrónica, mención Sistema Embebido e
Integración

Quito, mayo del 2020

UNIVERSIDAD SAN FRANCISCO DE QUITO USFQ

COLEGIO DE POSGRADOS

HOJA DE APROBACIÓN DE TRABAJO DE TITULACIÓN

ELECTRONICS SYSTEM ENGINEERING Flat-Sat for IGOSat

JUAN ANDRES VALVERDE JARA

Firmas

Julien Perchoux, PhD

Director Master ESECA, Toulouse, Francia

Omar Aguirre, PhD

Director de Maestría en Nanoelectrónica

César Zambrano, PhD

Decano del Colegio de Ciencias e Ingenierías

Hugo Burgos, PhD

Decano del Colegio de Posgrados



Quito, mayo del 2020

© Derechos de Autor

Por medio del presente documento certifico que he leído todas las Políticas y Manuales de la Universidad San Francisco de Quito USFQ, incluyendo la Política de Propiedad Intelectual USFQ, y estoy de acuerdo con su contenido, por lo que los derechos de propiedad intelectual del presente trabajo quedan sujetos a lo dispuesto en esas Políticas.

Asimismo, autorizo a la USFQ para que realice la digitalización y publicación de este trabajo en el repositorio virtual, de conformidad a lo dispuesto en el Art. 144 de la Ley Orgánica de Educación Superior.

Firma del estudiante:

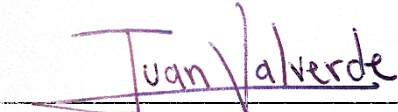

Nombre:

JUAN ANDRES VALVERDE JARA

Código de estudiante:

00204278

C. I.:

0104141940

Lugar, Fecha

Quito, mayo del 2020

ACLARACIÓN PARA PUBLICACIÓN

Nota: El presente trabajo, en su totalidad o cualquiera de sus partes, no debe ser considerado como una publicación, incluso a pesar de estar disponible sin restricciones a través de un repositorio institucional. Esta declaración se alinea con las prácticas y recomendaciones presentadas por el Committee on Publication Ethics COPE descritas por Barbour et al. (2017) Discussion document on best practice for issues around theses publishing, disponible en <http://bit.ly/COPETHeses>.

UNPUBLISHED DOCUMENT

Note: The following graduation project is available through Universidad San Francisco de Quito USFQ institutional repository. Nonetheless, this project – in whole or in part – should not be considered a publication. This statement follows the recommendations presented by the Committee on Publication Ethics COPE described by Barbour et al. (2017) Discussion document on best practice for issues around theses publishing available on <http://bit.ly/COPETHeses>.

ACKNOWLEDGMENTS

I am sincerely thankful to Mr. Hubert HELLOIN, Conference Master and Deputy Head in Gravitation Team and Mrs. Hanna BENHIZIA, Nanosatellite IGOSat Project Manager and Space System Engineer, at Laboratoire Astroparticules & Cosmologie (APC) and Institut de Physique du Globe de Paris (IPGP) for proposing this challenging and rewarding internship, I appreciated their continuous advice and valuable feedback during every step of the project.

I would also like to thank Mr. Marco AGNAN for his disposition and help.

I direct my appreciation to Mr. Julien PERCHOUX, Head of the International Master ESECA at INP-ENSEEIH, and Lionel Trojman, Head of the Master of Nano-electronics at USFQ who greatly inspired me on me throughout my Master studies in France.

I express my thankfulness for all members of the APC and my colleagues in IGOSat project with whom I worked for their support and greeting as well as all the teachers of ENSEEIH from whom I got the necessary basis of knowledge to be able to succeed in my first job experience in France.

Finally, I can never forget to mention my parents René and Mariana who are my reference, my uncles Carlos and Janet my help, Jose and Lucy my pillar, my uncles Xavier and Bertha my support, without their care I would not have fulfilled this goal and may God bless you all.

RESUMEN

El presente documento presenta el informe de pasantía final de mí, Juan Andrés VALVERDE JARA, en el Máster 2 ESECA del ENSEEIHT, yo cumplí con una pasantía de 6 meses en el Proyecto IGOSat en el Equipo de Electrónica Espacial como Ingeniero de Sistema Electrónico (Flat-Sat) y de prueba electrónico en el laboratorio (APC) Laboratoire Astroparticules & Cosmologie de la Universidad Paris Diderot en la ciudad de París en Francia entre el 8 de marzo de 2019 y el 30 de septiembre de 2019.

El presente documento escribe mis tareas sobre hacerme cargo de las interfaces eléctricas y de comunicación satelitales completas, tanto en un punto de vista de prueba como preparación de documentos técnicos.

Trabaje en un entorno multicultural parte de un equipo de 10 pasantes de diferentes orígenes.

Como ingeniero de sistema electrónico de este equipo, yo fui el punto de contacto para todo lo relacionado con el punto de vista del sistema electrónico del satélite.

Escribí, gestioné y actualicé documentos técnicos como el Documento de control de interfaz, el Documento de especificación de arneses de satélite, el Documento de atribución de pines de satélite y documentos de procedimientos de prueba.

Desde el punto de vista de la prueba, diseñé placas de interfaz para el satélite en KiCad y probé el Sistema de Energía Eléctrica (EPS) del satélite junto con otro interno.

Palabras clave: Nanosatélite, Flat-Sat, Interconexión, CubeSat,

ABSTRACT

The present document introduces the final internship report of Master 2 ESECA - ENSEEIHT student Juan Andres VALVERDE JARA fulfilled on a 6 months internship at the IGOSat Project in the Electronics Team as Electronics System Engineering (Flat-Sat) of Paris Diderot University and the city of Paris between the 8th Mars 2019 and the 30th September 2019.

This document writes my tasks about taking charge of the complete satellite communication and electrical interfaces, both from a test point of view and in the preparation of technical documents.

I worked in a multicultural environment part of a team of 10 interns from different backgrounds. As an electronic system engineer for this team, I was the point of contact for everything related to the viewpoint of the satellite electronic system.

I wrote, managed and updated technical documents such as the Interface Control Document, the Satellite Harness Specification Document, the Satellite Pin Attribution Document, and test procedure documents.

From the point of view of the test, I designed interface plates for the satellite in KiCad and tested the Electric Power System (EPS) of the satellite along with an internal one.

Key words: Nanosatellite, Flat-Sat, Interconnections, CubeSat,

INDEX

1 INTRODUCTION.....	13
1.1 Background of report	13
1.2 Terms of reference and acronyms	14
1.3 Profile of the organization	15
1.3.1. Background.....	15
1.3.2. Igosat project [1].	16
1.3.3. Cubesat [2] [3].	17
1.3.4. Igosat project overview.	18
1.3.5. Flight system architecture.	19
2 DESCRIPTION OF THE PROJECT	20
2.1 Igosat flight segment architecture	20
2.1.1. Sci – scintillator payload.....	20
2.1.2. Tel – telecommunications platform.....	23
2.1.3. Obc – on-board computer platform.....	24
2.1.4. Adcs – attitude determination and control platform.	25
2.1.5. Eps – electrical power source platform.	26
2.1.6. Gps – global positioning system payload.....	28
2.1.7. Str – structure.....	29
2.2 General and specific goals of the internship.....	31

2.3	State of the art	31
2.4	Problematic	32
2.4.1.	Challenge and limitations.....	32
3	DEVELOPMENT	34
3.1	Subsystem technical characteristics.	34
3.2	Interconnections design.....	35
3.2.1.	Pin attribution and stack connectors documentation in subsystems.....	39
3.2.2.	Harnesses design.....	44
3.2.3.	Couplers.....	54
3.3	Assembly, integration, and testing.	56
4	CONCLUSIONS.....	58
4.1	Recommendations	58
4.2	Perspectives	58
5	SOURCES.....	60

LIST OF TABLES

Table 1. Current rating approximation for the subsystems	34
Table 2. Current rating approximation for each payload and support platform in IGOSat.....	35
Table 3. Couplers in the whole satellite	38
Table 4. Connectors in the whole satellite.....	38
Table 5. Harnesses in the whole satellite.....	38

LIST OF FIGURES

Figure 1. IGOSat Project Overview	18
Figure 2. IGOSat Flight Segment Architecture – Full product tree	19
Figure 3. SCI Payload conceptual diagram	21
Figure 4: Scintillator and SiPM schematic	22
Figure 5: General schematics of the detection system.....	22
Figure 6: SCI (TOP: detector and support board, MIDDLE: shielding BOTTOM: EASIROC Board), with the reference frames	22
Figure 7. TEL conceptual diagram	23
Figure 8: TEL (TOP: Communication Board, BOTTOM: Antenna Board “deployed”) and the reference frames.....	24
Figure 9. OBC conceptual diagram.....	24
Figure 10: OBC (TOP: FM Daughterboard, BOTTOM: OBC Board) and the reference frames	25
Figure 11. ADCS conceptual diagram	25
Figure 12: ADCS and the reference frames.....	26
Figure 13. EPS conceptual diagram	27
Figure 14: Illustration of EPS (TOP: Battery Board, BOTTOM: Power Board), the reference frame of the EPS.....	28
Figure 15. GPS conceptual diagram	28
Figure 16. Radio occultation schema	29
Figure 17: GPS (TOP: GPSRM Board, BOTTOM: Antenna) and the reference frames	29
Figure 18. STR conceptual diagram.....	29

Figure 19. IGOSat assembled model view with the reference frame	30
Figure 20. Stack connectors, couplers, and harnesses in the whole satellite	37
Figure 21. PC-104 stack and a PCB format drawing for Cubesat	39
Figure 22. TOP cube stack connectors documentation	41
Figure 23. MIDDLE cube stack connectors documentation	42
7Figure 24. BOTTOM cube stack connectors documentation	43
Figure 25. Harness used for EPS testing.....	44
Figure 26. Documentation for the harness H1.....	45
Figure 27. Documentation for the harness H2.....	45
Figure 28. Documentation for the harness H3H4	46
Figure 29. Documentation for the harness H5.....	47
Figure 30. Documentation for the harness H6.....	48
Figure 31. Documentation for the harness H7.....	49
Figure 32. Documentation for the harness H8.....	50
Figure 33. Documentation for the harness H9.....	51
Figure 34. Documentation for the harness H10.....	52
Figure 35. Documentation for the harness H11.....	52
Figure 36. Documentation for the harness H12.....	53
Figure 37. PC104 Documentation to design the coupler U1_TEL_to_OBC and U2_OBC_to_TEL	54
Figure 38. PC104 Documentation to design the coupler U3_ADCS_to_EPS and U4_EPS_to_ADCS	55
Figure 39. Coupler U1_TEL_to_OBC (left) and U2_OBC_to_TEL (right)	56

Figure 40. Coupler U3_ADCS_to_EPS (left) and U4_EPS_to_ADCS (right)	56
Figure 41. Functional Model Engineering Test for OBC (left) and EPS (right)	57

INTRODUCTION

1.1 Background of report

As part of the one year studies in the master degree of **Aéronautique et Espace Parcours type: <<Master of Science - ELECTRONIC SYSTEMS FOR EMBEDDED AND COMMUNICATING APPLICATIONS - ESECA>> year 2** per the requirement of the Institut National Polytechnique de Toulouse INP-ENSEEIH at Toulouse, it is mandatory for students in the Specialized Masters of the Conférence des Grandes Écoles to perform an graduation internship in a Company or Laboratory from 4 to 6 months following Master and it could be from February to the end of September 2019.

The report is written one month before the end of the internship by the student who is part of the award of the degree certificate. I did a six months internship between the 8th Mars 2019 and the 30th September 2019 at Paris Diderot University, specifically at the Astro Particle and Cosmology (APC) Laboratory. I was assigned to the Electronics Team as Electronics System Engineering (Flat-Sat) in the IGOSat Project. The main task is to understand and work with each subsystem and each payload to integrate it into the complete satellite system making the correct interconnection and test it.

The internship helps students to be able to carry out the entire engineering mission taking into account scientific, technical, economic, environmental, organizational and humans aspects, on the other hand helps to implement a project management approach, demonstrate initiative and respond to the proposed situation in a relevant way and be able to report on a project and defend its results by adapting to the target audience.

1.2 Terms of reference and acronyms

- IC –Integrated Circuit
- DUT – Device Under Test
- EUT – Equipment under test
- IGOSat – Ionospheric Gamma-ray Observation Satellites
- EQM – Engineering, Qualification Model
- FM – Flight Model
- EM – Engineering Model
- STR – Structure
- SCI – Scintillator Payload
- ADCS – Attitude Determination Control System
- GPS – Global Positioning Services
- OBC – On-Board Computer
- TEL – Telecommunication
- EPS – Electrical Power System
- AIT – Assembly, Integration, and Testing
- SE – System Engineering
- ICD – Interface Control Documents
- EPS – Electrical Power Supply
- CNES – Centre National Etude Spatiale
- ME – Mechanical Engineer
- (P)-POD – (Poly) – Picosatellite Orbital Deployer

- ISIS – Innovation Solutions in Space
- RBF – Remove Before Flight
- KS – Kill-Switch
- SCL – Serial Clock
- SDA – Serial Data
- UART – Universal Asynchronous Receiver Transmitter
- SPI – Serial Peripheral Interface
- MISO – Master Input Slave Output
- MOSI – Master Output Slave Input
- SiPM – Silicon Photomultiplier
- MC – Microcontroller
- FW – Firmware
- MPPT – Maximum Peak Power Tracking

1.3 Profile of the organization

1.3.1. Background.

Some years ago, the interest in CubeSat projects has been incrementing because of the advantage of being low cost for promising scientific results. Paris Diderot University created a Student Space Centre in 2014 to get involved in the development of nanosatellites. Some institutions have co-operated to deliver this student space mission at Paris Diderot Campus:

- APC – Laboratoire Astroparticule & Cosmologie
- IPGP – Institut De Physique Du Globe De Paris
- CNES – Centre national d'études spatiales in the French educational satellite program
JANUS – Jeunes en Apprentissage pour la réalisation de Nanosatellites au sein

des Universités et des écoles de l'enseignement Supérieur

1.3.2. Igosat project (NGUYEN, 2018).

IGOSat - Ionospheric & Gamma-ray Observation Satellite is the first CubeSat student at the Paris Diderot University. The mission operates in a quasi-polar orbit at 650km from the earth and it is based on two objectives (two payloads):

1. A dual-frequency GPS receiver for the study of the total electronic content (TEC) of the ionosphere, a region of the terrestrial atmosphere located between 60 and 800 km altitude by GPS occultation, measuring the phase shift of L1 and L2 signals.
 - i. L1: general frequency of 1575.42 MHz
 - ii. L2: general frequency of 1227.60Mhz
2. A scintillator and a silicon photomultiplier SiPM for the study of the gamma-ray spectrum (energy between 20keV to 2MeV) and electrons (energy between 1MeV to 20MeV) in aurora areas and above the South Atlantic Anomaly (SAA) by using the XGRE/TARANIS example which is currently under development in APC.

IGOSat satellite began in 2012 with a feasibility study called *Phase 0* and completed in 2014. After, the feasibility and the preliminary definition called *Phase A* and *B* respectively followed with a phase B review in June 2016 with the architectural design, the structural model and the thermal model as well as the ground installation was completed. Following this, the detailed design of all subsystems called *Phase C* has been completed in September 2017. Till the date, the project is in the Production / Qualification of the system called *Phase D*, aiming to deliver the Flight Model on the ground, we are currently working on the integration and testing of

the subsystems. The use/operation called Phase E, which marks the launch and start of IGOSat satellite operations, is expected by the end of 2020. The duration of the mission will be one year after the launch. The end of the useful life of the satellite, phase F, is expected before 2044, a date governed by the law of space operations that postulates that the satellite must be de-orbited no later than 25 years after its launch. Throughout the years of development, more than 200 students from all over the world have collaborated in the project.

1.3.3. Cubesat (NASA, 2017) (JANUS; CNES, 2016).

Artificial satellites vary in size and cost depending on the use. According to NASA we have large satellites with a mass more than 1000 kg, medium-sized satellites between 500 - 1000 kg and small satellites that are classified in Minisatellites between 100 - 500 kg, Microsatellites between 10 - 100 kg, Nanosatellites (*CubeSats are in this category*) between 1 - 10 kg and Picosatellites less than 1 kg.

The CubeSat standard defines specific criteria that control factors such as shape, size, and weight. Due to the standardized aspects, the companies produce the components in mass and it makes the development small expensive and reduces the cost related to the transporting and the deploying. The standard allowing to combine cubic units. The “unit” is 1U and it means a 100 mm cube with a mass of approximately 1 – 1.33 Kg and an approximate power of 1W. We can find sizes to 1.5U, 2U, 3U, 6U and 12U with a lifetime from 1 to 2 years (or more). **IGOSat** was set out to be a 3U (three units).

The nanosatellites are widely used for the pedagogic frame for the futures space engineers, the validation of technologies in orbit, scientific missions, interplanetary scientific missions, new applications for the civil society and the defense (constellations of observation of the Earth, listening, etc).

1.3.4. Igosat project overview.

The whole IGOsat project is defined clearly by the graph below:

The Flight Segment (FS) consists of three CubeSat units where we have payloads and platforms.

The Ground Segment (GS) comprises the infrastructure required for the ground command, control, communications, operations, data archiving and distribution.

The Launch Accommodation Segment includes the Launch Vehicle (called P-POD for CubeSats) and the related infrastructure at the launch site.

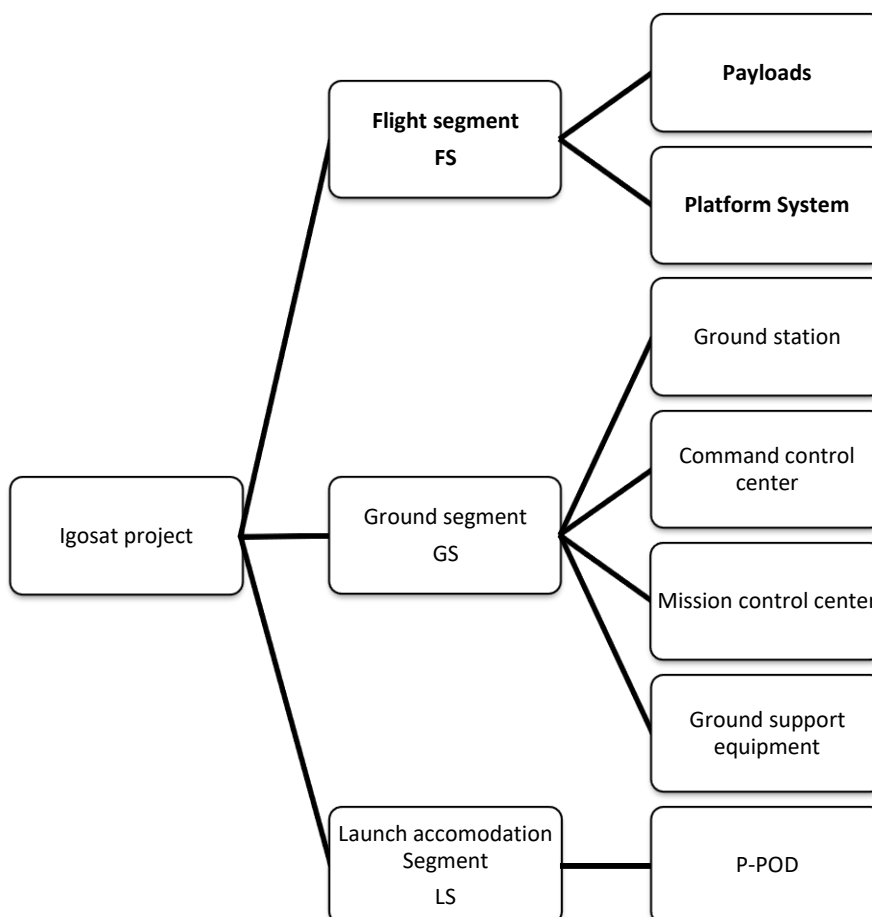

Figure 1. IGOsat Project Overview

1.3.5. Flight system architecture.

In IGOSat the Flight Segment Architecture comprises two payloads and five support platforms, with the OBC as the central unit of information and distribution for any flight control and the EPS as the central power supply for the whole satellite system.

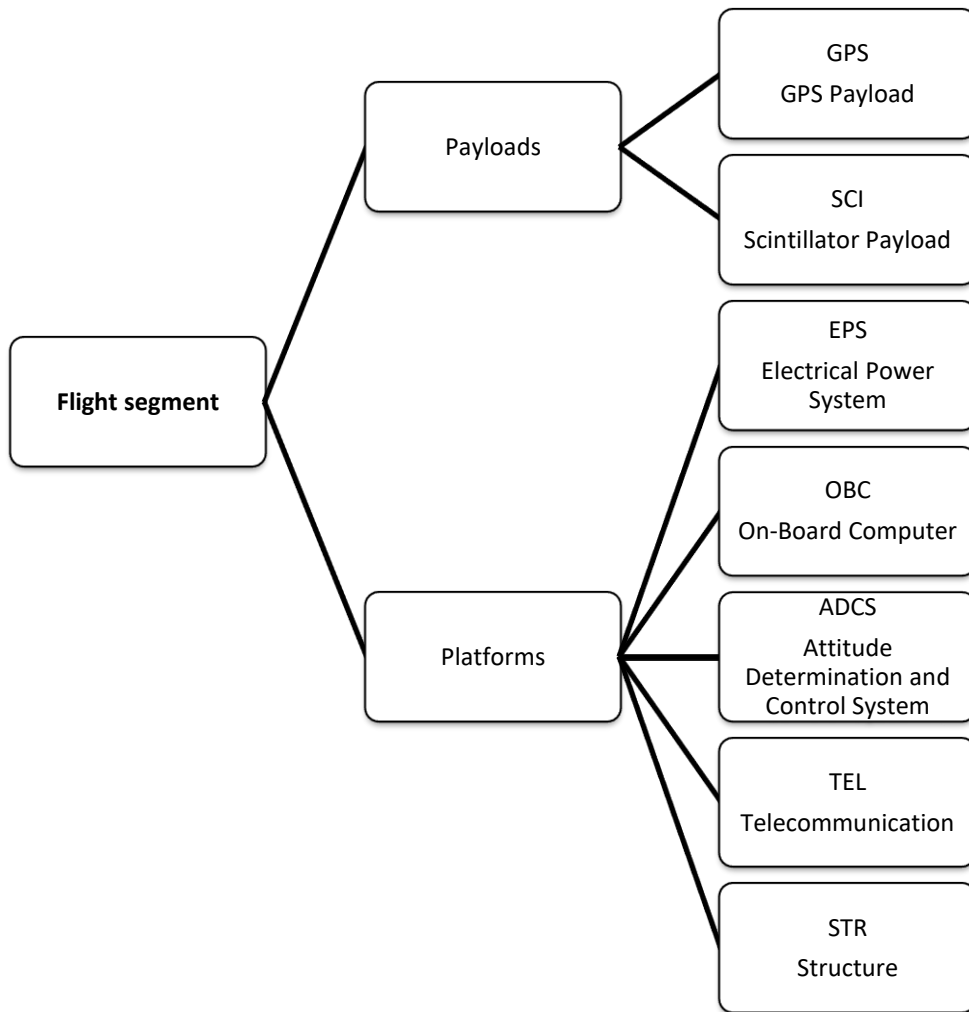

Figure 2. IGOSat Flight Segment Architecture – Full product tree

DESCRIPTION OF THE PROJECT

2.1 Igosat flight segment architecture

The IGOSat Flight Segment Architecture is comprised of two payloads and five support platforms but, each payload or support platform is composed of different elements such as PCBs, sensors, actuators, etc. In this section, I put in context each of them with its components.

2.1.1. Sci – scintillator payload.

The scintillator payload is being developed by IGOSat and it is composed of two printed circuit boards: Support board (it contains the Detector) and the EASIROC board.

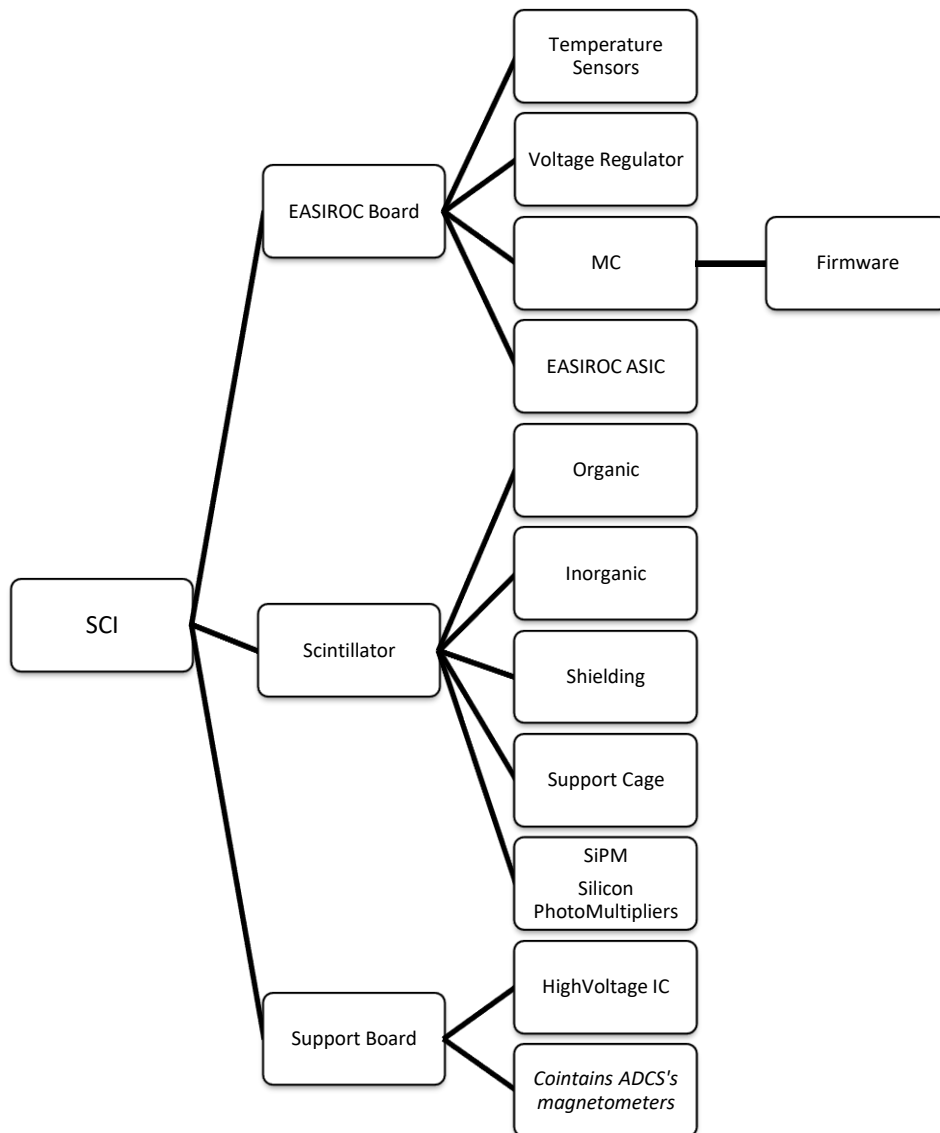

Figure 3. SCI Payload conceptual diagram

The detector of IGOsat has a goal to identify gamma-ray from 200keV to 2MeV and electron from 1MeV to 20MeV. It is made of scintillator materials that are organic and inorganic; read out by Silicon PhotoMultipliers (SiPM).

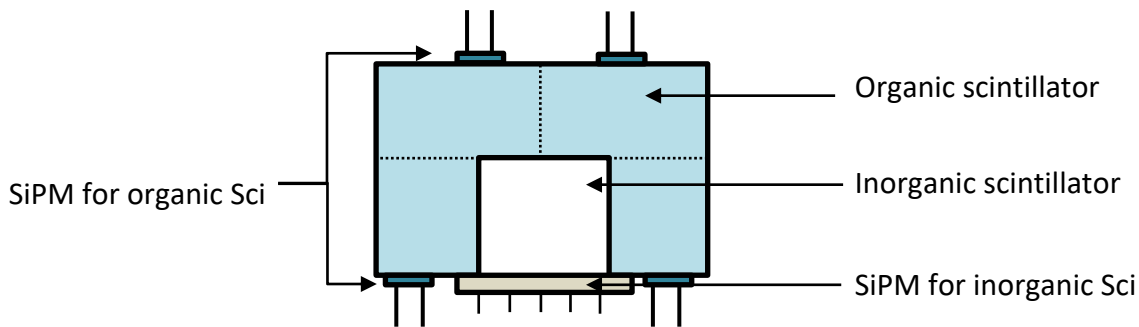

Figure 4: Scintillator and SiPM schematic

The raw output signals from the SiMP (Silicon PhotoMultiplier) are treated and analyzed by the EASIROC ASIC board developed by the CNRS Omega team and after manipulated and send it by the microcontroller to the OBC.

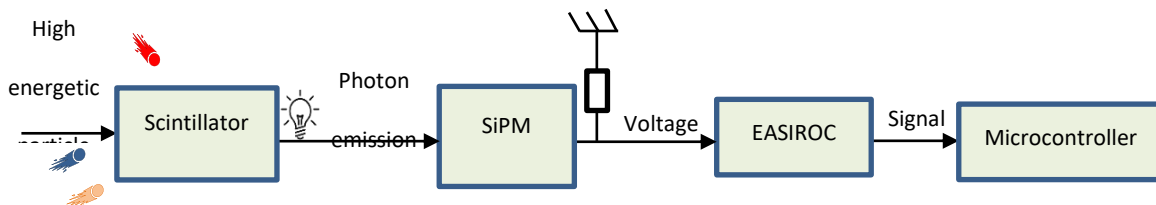

Figure 5: General schematics of the detection system

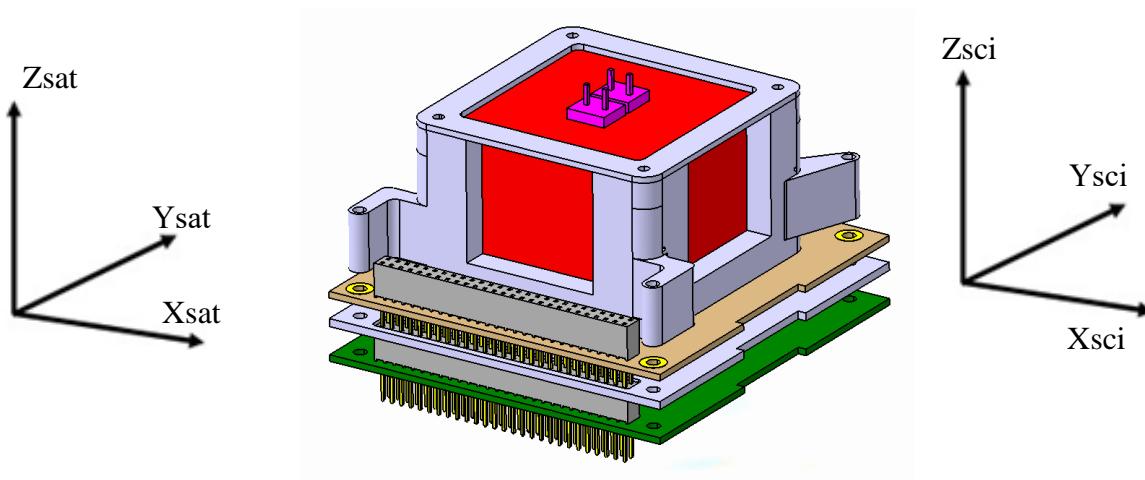

Figure 6: SCI (TOP: detector and support board, MIDDLE: shielding BOTTOM: EASIROC Board), with the reference frames

2.1.2. Tel – telecommunications platform.

The telecommunication platform was designed by ISIS and it is composed of two boards: the communication board and the antenna board

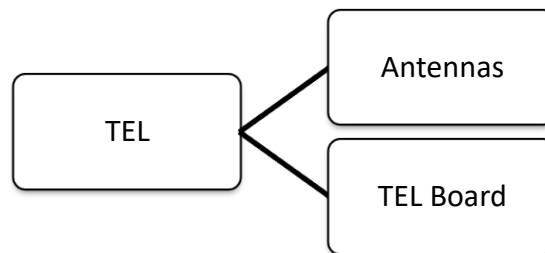

Figure 7. TEL conceptual diagram

In this document, the Telecommunications platform corresponds to the space segment because it refers to the hardware, firmware, antennas and the printed circuit board placed onboard the satellite. (Aristotle Space & Aeronautics Team, s.d.)

The telecommunication card is used to send and receive remote commands via antennas. The following types of data are exchanged between the space and ground segment:

- Telemetry: Diagnostic information regarding the state of the satellite
- Telecommand: Commands from the ground station to the satellite
- Payload: Scientific data stemming from the experiment

The telecommunication antennas are four, two UHF for the Downlink (broadcast) and two VHF for the Uplink (reception).

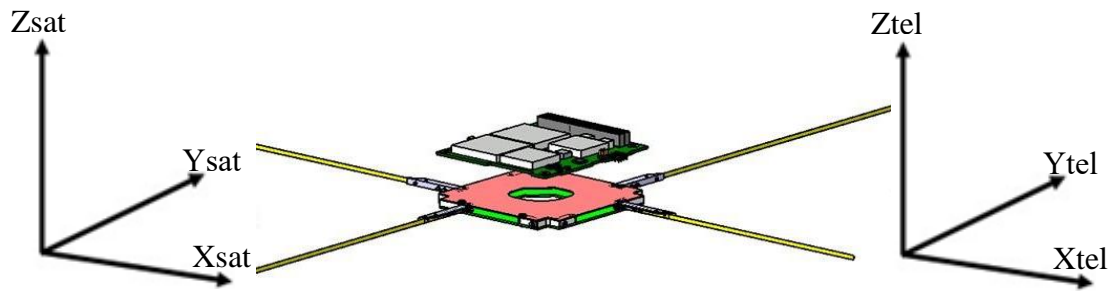

Figure 8: TEL (TOP: Communication Board, BOTTOM: Antenna Board "deployed") and the reference frames

2.1.3. Obc - on-board computer platform.

The OBC was designed by ISIS and it is composed of two printed circuit boards: the OBC board and the FM Daughterboard.

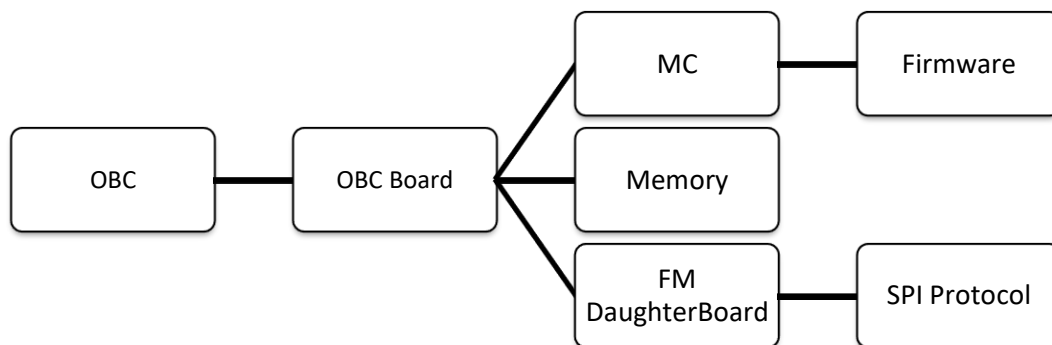

Figure 9. OBC conceptual diagram

The term OBC means On-Board Computer and this system provides processing capability to the satellite, it is the unit where the On-Board Software runs the functions like attitude and orbit control, telecommands execution or dispatching, housekeeping telemetry gathering, and formatting, onboard time synchronization and distribution, failure detection, isolation, recovery, etc. (ESA, s.d.)

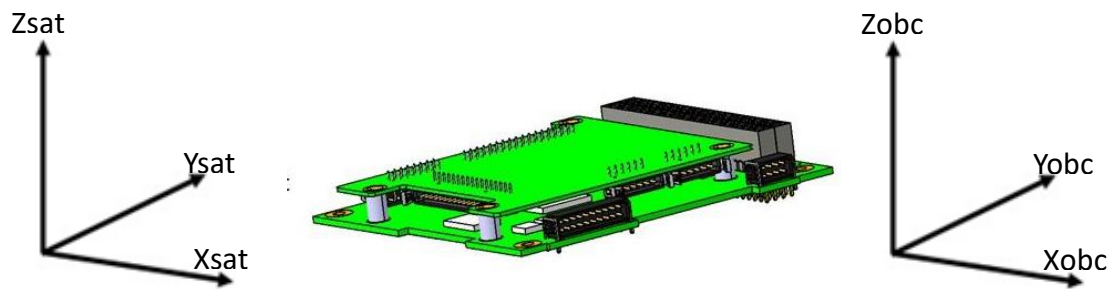

Figure 10: OBC (TOP: FM Daughterboard, BOTTOM: OBC Board) and the reference frames

2.1.4. Adcs - attitude determination and control platform.

The ADCS platform is being developed by IGOSat and it is composed of the ADCS board (including actuators like the air coil and Ferro coil) and the reaction wheel (it is another actuator).

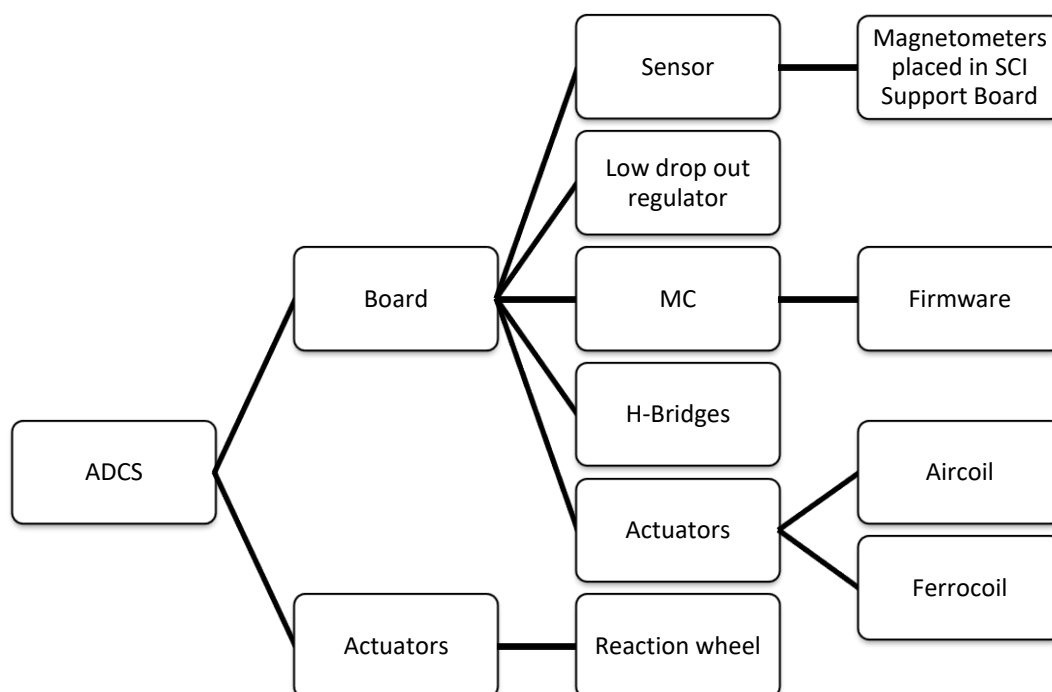

Figure 11. ADCS conceptual diagram

The Attitude Determination and Control System (ADCS) ensures the correct orientation of the satellite. It involves *Actuators* to move in space, *Sensors* are the attitude source, *The Controller* collects and processes the data and *the PC104 connector* permits to communicate with sensors and it also distributes the voltage coming from the power supply. (ECE Paris, s.d.)

The reaction wheel will be connected to the ADCS, it is used at a constant speed as an inertia wheel. It makes it possible to align the moment of inertia of the reaction wheel with the orbital moment of inertia of the satellite. The work of the magneto couplers to correctly orient the satellite is then facilitated.

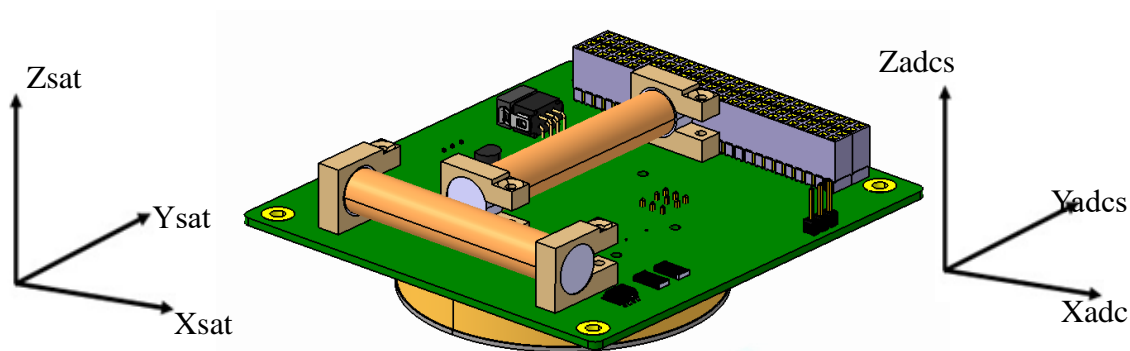

Figure 12: ADCS and the reference frames

Note: Reaction wheel is not represented

2.1.5. Eps - electrical power source platform.

The EPS is being developed by IGOSat and it is composed of two printed circuit boards: the Battery Board and the Power Board.

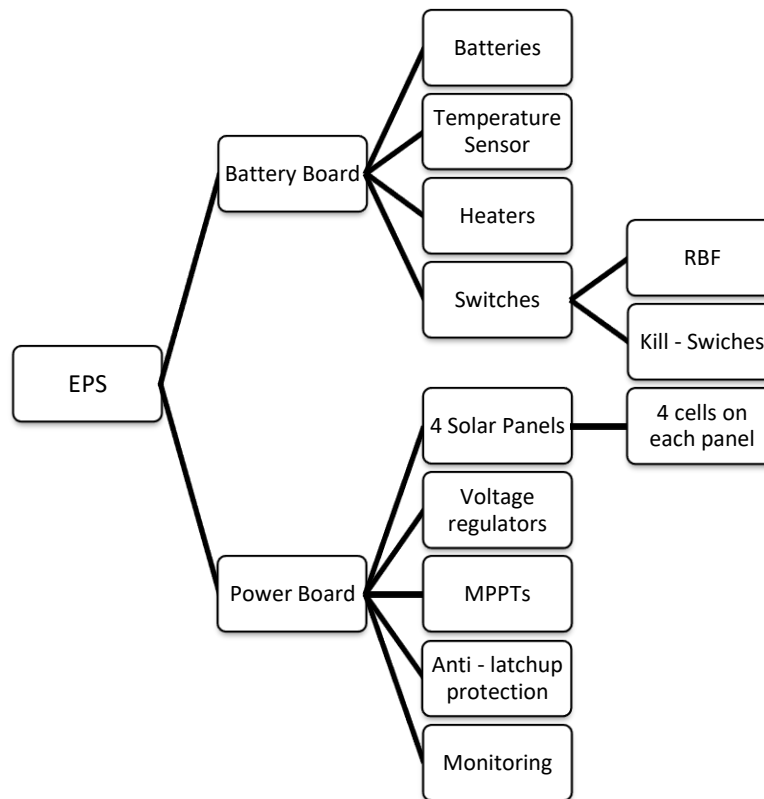

Figure 13. EPS conceptual diagram

The Power Board is used to deliver different stable voltages for the entire CubeSat electrical power needs (subsystems and payloads). This board consists mainly of voltage converters and protection circuits. (Ibrahim, 2012)

The "Kill Switch" and the RBF (Remove before flight) will be connected to this card, whose role is to disconnect the batteries from the satellite when it will be embarked on the P-POD (Poly Picosatellite Orbital Deployer) inside the launcher until release into orbit.

The battery card is recharged by 6-cell solar panels on each longitudinal side of the satellite.

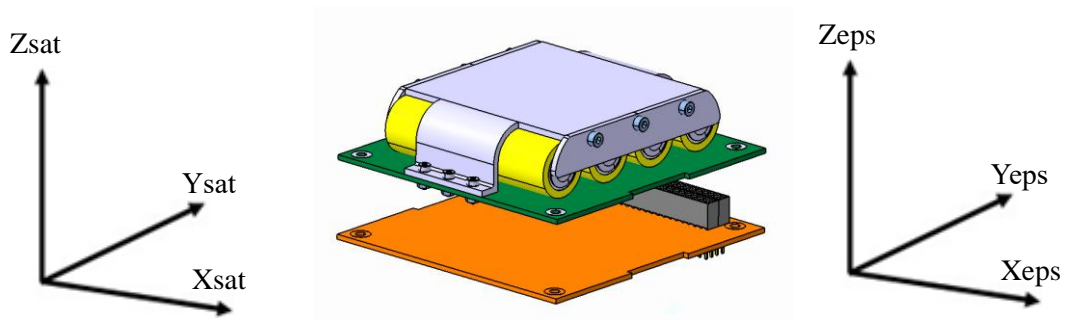

Figure 14: Illustration of EPS (TOP: Battery Board, BOTTOM: Power Board), the reference frame of the EPS

Note: Solar panels are not represented

2.1.6. Gps – global positioning system payload.

The GPS payload was developed by Pumpkin, Inc. and it is composed of the GPSRM printed circuit board and the GPS Antenna.

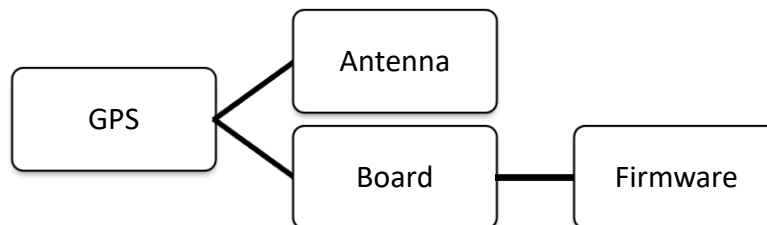

Figure 15. GPS conceptual diagram

The main function of the GPS instrument is to provide useful data to calculate the absolute Slant Total Electron Content (STEC), which means the TEC along the ray path between IGOSat and a given GPS satellite.

The GPS antenna receives satellite signals from the GPS constellation.

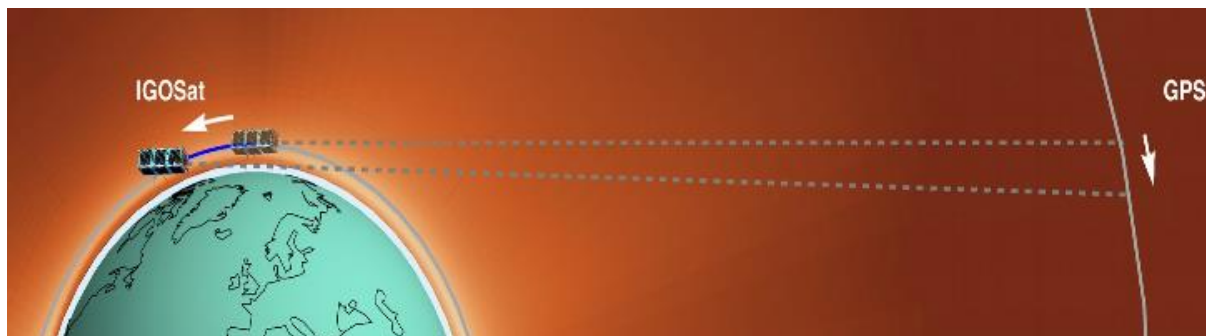

Figure 16. Radio occultation schema

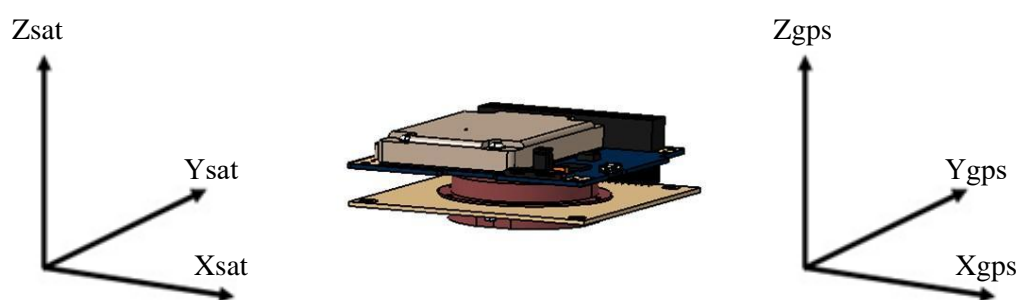

Figure 17: GPS (TOP: GPSRM Board, BOTTOM: Antenna) and the reference frames

2.1.7. Str – structure.

The Structure is composed of the Skeleton and the Mass balance.

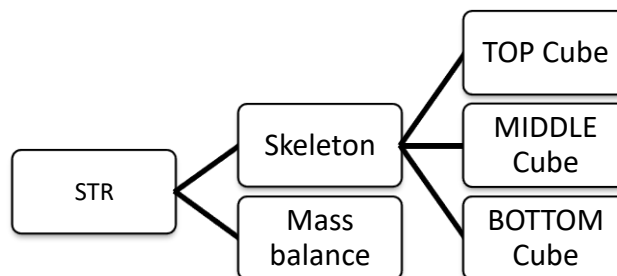

Figure 18. STR conceptual diagram

The skeleton is designed by IGOSat following the standard 3U CubeSat (California Polytechnic

State University, 2014). This structure gives us the maximum flexibility, accessibility, and integration to stacks of PCBs, or other modules, to be mounted inside the chassis. (ISIS)

The mass balance helps the nanosatellite to reduce the magnitude of the on-orbit external disturbing torques, re-locating the center of mass (CoM) as close as possible to the geometrical center of the spacecraft. (Humberto, 2018)

The axis x is collinear with the long axis of the connectors PC 104. The axis z is collinear with the axis of the length of the satellite directed from the bottom of the latter (Antenne GPS) upwards (Scintillator payload). The axis y comes to terminate the coordinate system orthogonal to the axes z and x.

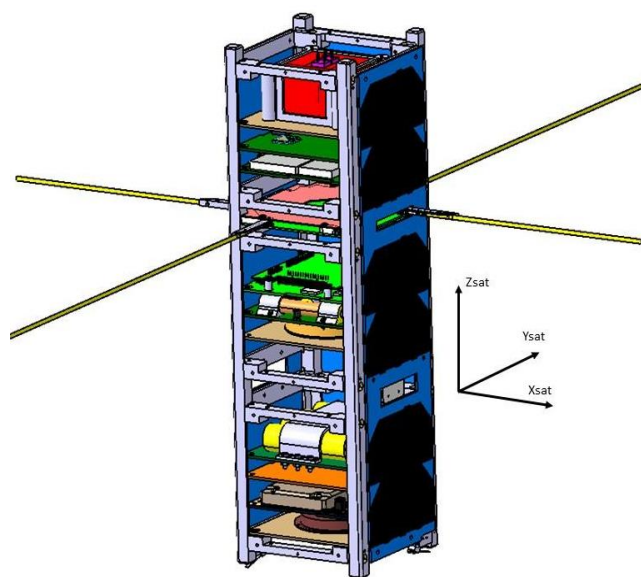

The IGOSat 3U CubeSat system layout

CUBE 1 – Top:

- SCI
- TEL

Antenna Card - Between Top – Middle

CUBE 2 – Middle

- OBC
- ADCS

Reaction Wheel - Between Middle – Bottom

CUBE 3 – Bottom

- EPS
- GPS

Figure 19. IGOSat assembled model view with the reference frame

2.2 General and specific goals of the internship

In my internship agreement, the general goal is ELECTRONICS SYSTEM ENGINEERING FLAT-SAT

In my internship agreement, the specific goals are:

- Writing of test protocols and electronic unit tests
- A global test of the satellite model "on-table"
- Verification and validation of the results in comparison with the specifications

2.3 State of the art

During the internship period, I was assigned to the Electronics Team composed by General Electronics, the EPS and Flat-Sat. This team is responsible for the design, development, function, and testing of the sub-systems and the payloads electronics in the flight segment. The job assigned to me is related to the integration of the systems and the payloads, the Flat-Sat test for the whole satellite.

Igosat Team 2019 is composed by an international squad where the members are from all over the world, the team is composed by Duy K. DGUYEN (Vietnam) in the Scintillator payload, Flavien GUICHOU (France) in the GPS payload, Yanli HE (China) in the General Electronics, Imad AYOUB (Argelia) in the EPS (Electrical Power System), Juan VALVERDE (me) (Ecuador) in the Electronics System Engineer - Flat-Sat, Quân Anh BÙI (Vietnam) in the Mechanics, Leo COIC (France) in the ADCS (Attitude Determination and Control System), Corentin GUIGNOT (France) in the Mechanics and Thermic, and Amar BOULENOUAR (Argelia) in the EASIROC.

At the beginning of the internship period, I followed the instructions of the Project Manager reading and reviewing the documentation of the project. I read the Definition Files that are

documents related to the operation of payloads and platforms and that are all managed internally. Next, the documents that I had to handle are the INTERFACE CONTROL DOCUMENT (ICD) and the SYSTEM ENGINEERING Assembly, Integration and Testing that are internal master documents and describe the entire system.

2.4 Problematic

I realized that some parts of my documents need further analysis since everything must be defined before integration and testing. Extracting information from both the Definition Files and the support of the team members, I started by performing the SUBSYSTEM TECHNICAL CHARACTERISTICS of the payloads and the platforms. For the integration, I created a new document with the pin attribution in each cube of the CubeSat, and then I designed documents with the description of all the required harnesses, this led me to make a complete IGOSat scheme with arrows that describe all the interconnections. Because of not finding a feasible solution to interconnect two PC104, the idea of using Couplers, which I designed to meet the specifications, was consolidated. In the testing stage, I gave support for the integration of the solar panel and the EPS. In the integration, I am working with the Space Mechanical Engineer and my work will end with the power budget of the system.

2.4.1. Challenge and limitations.

I must be kept in constant monitoring of the changes that are made in the subsystems as well as the mechanical part.

I have the challenge of working in a cross-development environment carrying out the documentation of the integration/processes/testing/etc. under IGOSat standard.

A cross-development environment has the challenge of dependence related to the

manufacturer's deadlines and the time that the development takes.

I have the challenge of developing high-level documentation to communicate in a simple, structured and easy form to everyone who needs to work or understand the project.

DEVELOPMENT

3.1 Subsystem technical characteristics.

The next table resumes the payloads and support platforms voltage supply and communication needs, I extracted this information from the Definition Files and the support of the team members.

System	Subsystem	Voltage Supply needs (DC) [V]				Communication needs			
		3,3	5	Vbatt (7,2)	Others	I2C	SPI	UART	Others
SCI	Detector				54				Analog
	Support board	x	x		2,5	x	x	x	Analog
	EASIROC Board	x		x		x	x		
TEL	TRXVU Board			x		x			
	Antenna Board	x				x		x	RF
OBC	OBC	x	x			x		x	
	Daughterboard						x		
ADCS	ADCS Board			x		x	x		
	Magnetorquers (Located in the SCI Support Board)	x				x			
	Reaction wheel	x				x			
	Magnetometers	x				x			
EPS	Battery board					x			
	Powerboard			x	SP	x			
	Solar Panel					x			
GPS	GPSRM Board	x	x			x		x	RF
	Antenna				2.5 to 16				RF

Where:

RF Radio Frequency

SP Solar Panels

Table 1. Current rating approximation for the subsystems

The next table resumes the payloads and support platform's current rating approximation, the Scintillator payload current rating is not yet determined. I extracted this information from the

Definition Files and the support of the team members.

System	Subsystem	Typical	Notes
TEL	TEL	410mA@8V	MAX 600mA@8V with Rx and Tx ON
	TEL Antenna	9mA@20°C	0,56A@3,3V Deployment 3 s
OBC	OBC	115mA	380mW@3,3V
	Daughterboard		Included in the ADCS board
ADCS	ADCS board	500mA	Estimate
	Reaction Wheel		Included in the ADCS board
EPS	OBC	115mA	380mW@3,3V
	Daughterboard		Included in the ADCS board
GPS	GPSRM board	300mA	
	Antenna		Included in the GPSRM board

Table 2. Current rating approximation for each payload and support platform in IGOSat

3.2 Interconnections design.



We have payloads, platforms, sensors, antennas and actuators located in a fixed place inside the flight segment of IGOSat in one of the three cubes but, they need some requirements to work correctly, for example, data transmission, power supply from the EPS, etc. To perform the integration and to connect the payloads and the platforms between them, the satellite has two types of interconnections: Harnesses and Connectors.

I worked permanently with the Project Manager support to compile all the information related with the payloads and platforms coming from ISIS documentation for the TEL platform (Communication and Antenna board) and the OBC platform (included the FM Daughterboard), CubeSat Kit and PUMPKIN documentation for the GPS payload and the IGOSat interns experience with Ial documentation compiled by previous interns that worked in Definition Files, System Engineering (Assembly, Integration, and Testing) and ICD (Interface and Control Document) which are sources of project information. For the mechanical requirements, I had

the help of the mechanical space engineer and the Project Manager.

The next figure presents us with the complete interconnections diagram of the whole satellite.

This is an electronic document for IGOSat Team, it is called "INTERCONNECTIONS DOCUMENTATION".

	INTERCONNECTIONS DOCUMENTATION		Réf. : XXX-YY-NN Edition : 1 Date : XX-XX-XX Révision : 0 Date : XX-XX-XX
			Ionospheric and gamma-ray Observations Satellite 
AUTOR: Juan VALVERDE SECTION: Electronics System Engineering DATE: 24/07/2019	DESCRIPTION: The satellite has two types of interconnections to connect the sub-systems: Harnesses and Connectors. The couplers help us to use H3, H4, and H6 with the PC104		

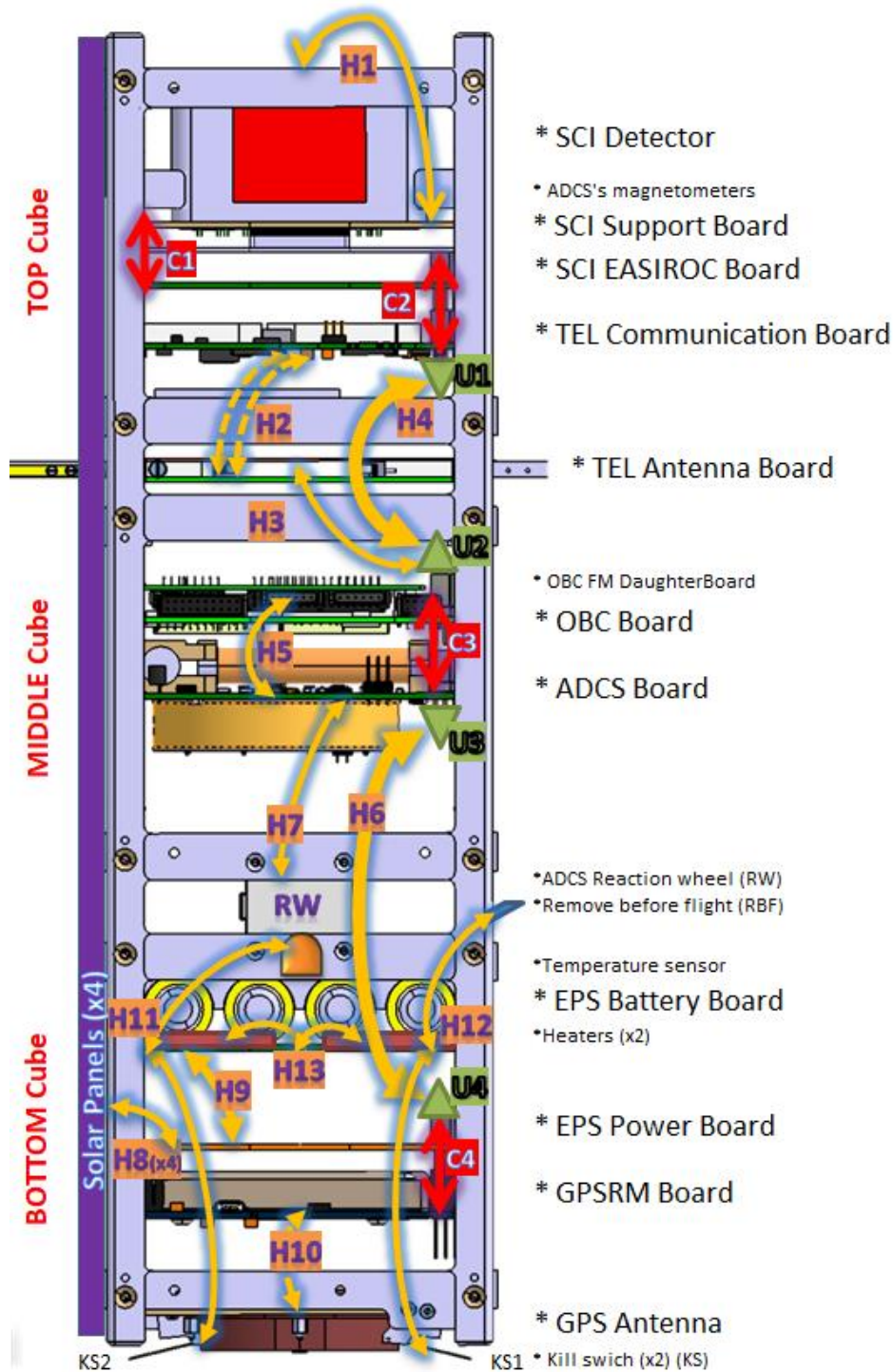

Figure 20. Stack connectors, couplers, and harnesses in the whole satellite

COUPLERS (from stack PC104) in green color		
LABEL	From	To
U1	TEL Communication Board	OBC Board
U2	OBC Board	TEL Communication Board
U3	ADCS Board	EPS Power Board
U4	EPS Power Board	ADCS Board

Table 3. Couplers in the whole satellite

CONNECTORS (Stack PC104) in red color			
LABEL	Type	From	To
C1	<i>54-pines</i>	SCI Support Board	SCI EASIROC Board
C2	PC 104	SCI EASIROC Board	TEL Communication Board
C3	PC 104	OBC Board	ADCS Board
C4	PC 104	EPS Power Board	GPSRM Board

Table 4. Connectors in the whole satellite

HARNESSES in orange color			
LABEL	Type	From	To
H1	Wires	SCI Detectors	SCI Support Board
H2	<i>Radio Freq.</i>	<i>TEL Communication Board</i>	<i>TEL Antenna Board</i>
H3	Wires	U2	TEL Antenna Board
H4	Wires	U2	U1
H5	Wires	FM DaughterBoard	ADCS Board
H6	Wires	U3	U4
H7	Wires	Reaction Wheel	ADCS Board
H8	Wires	Solar Panels	EPS Power Board
H9	Wires	Battery Board	EPS Power Board
H10	<i>Radio Freq.</i>	<i>GPSRM Board</i>	<i>GPS Antenna</i>
H11	Wires	Battery Board	Kill-Switches
H12	Wires	Remove before flight	EPS Battery Board

Table 5. Harnesses in the whole satellite

3.2.1. Pin attribution and stack connectors documentation in subsystems.

The CubeSat standard was developed around the PC-104 connector specification where we can accommodate PCB cards to be stacked vertically in a 100 mm profile for 1U CubeSat's. PC104 allows various data transmission protocols. A single pin permits a current of 5.2 Amperes (SAMPTEC). PC104 connectors are located in almost all sub-systems of IGOsat. (Consortium, PC/104 Embedded, 2008) (DEBES, 2011)

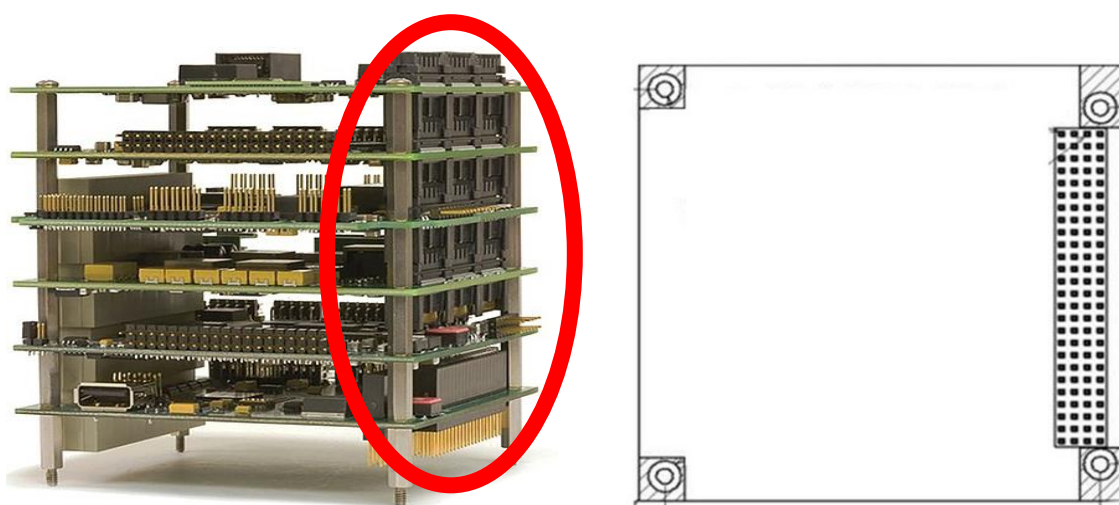

Figure 21. PC-104 stack and a PCB format drawing for Cubesat

To describe each stack connector and each pin in the connector we took reference in the 3U that CubeSat has but, that is a part of the complete electronic document called "PIN ATTRIBUTION AND STACK CONNECTORS DOCUMENTATION IN SUBSYSTEMS" that presents the pin attribution in every subsystem of the whole satellite, the document diagrams contain comments that explain the type and operation of each pin.

In the case of the TOP cube Figure 22; it has two stack connectors a 54-pin for the Support board, a PC104 connector specification for the EASIROC board, and a PC104 connector

specification for the TRXVU board. The 54-pins connector makes an interconnection between the SCI Support board and the EASIROC board, and the PC104 connector makes an interconnection between the EASIROC board and the TRXVU board.

In the case of the MIDDLE cube Figure 23, it has a PC104 stack connector that makes an interconnection between the OBC board and the ADCS Board.

In the case of the BOTTOM cube 7Figure 24, it has a PC104 stack connector too that makes an interconnection between the EPS Power board and the GPSRM Board.



				PIN ATTRIBUTION AND STACK CONNECTORS DOCUMENTATION IN SUBSYSTEMS																				Réf : XXX-YY-NN Edition : 1 Révision : 0 Date : XX-XX-XX Date : XX-XX-XX Ionospheric and gamma-ray Observations Satellite 					
		AUTOR: Juan VALVERDE SECTION: Electronics System Engineering DATE: 13/06/2019		DESCRIPTION: #Pin Type Pin Name		Pin description VCC SYS: 3.3V																							
								SPI Comes from the ADCS. For Programming CS-A CS-B Enable I2C level translation for Magnetometer A&B INPUT SCL-2 SDA-2 I2C for Magnetometer A and B TEMP-2 Temperature Sensor 2 OUT DDM, DDP From EASIROC MC, USB Device Port Data -> VMONHT High Voltage Signal VbatCH+ Charge the Battery VbatCH- Charge the Battery																					
								A(F2) A(E1) A(D2) A(D4) A(B2) A(B4) A(A1) A(A3) A(C1) A(C3) A(F1) A(G2) A(I2) A(E2) A(D1) A(D3) A(B1) A(B3) A(H2) A(A2) A(A4) A(C2) A(C4) A(H1) A(G1) A(I2)																					
TOP CUBE	Sub system 1: Support Board	J2	2 Analog A(F2)	4 Analog A(E1)	6 Analog A(D2)	8 Analog A(D4)	10 Analog A(B2)	12 Analog A(B4)	14 Analog A(A1)	16 Analog A(A3)	18 Analog A(C1)	20 Analog A(C3)	22 Analog A(F1)	24 Analog A(G2)	26 Analog A(I2)	28 Power VCC_SYS	30 Power VCC_SYS	32 Power VCC_SYS	34 Power VCC_SYS	36 Power VCC_SYS	38 Power VCC_SYS	40 Power VCC_SYS	42 Power VCC_SYS	44 Power VCC_SYS	46 Power VCC_SYS	48 Power VCC_SYS	50 Power VCC_SYS	52 Power VCC_SYS	54 Power VCC_SYS
		J2	1 Power GND	3 Power GND	5 Power GND	7 Power GND	9 Power GND	11 Power GND	13 Power GND	15 Power GND	17 Power GND	19 Power GND	21 Power GND	23 Power GND	25 Power GND	27 Power GND	29 Power GND	31 Power GND	33 Power GND	35 Power GND	37 Power GND	39 Power GND	41 Power GND	43 Power GND	45 Power GND	47 Power GND	49 Power GND	51 Power GND	53 Power GND
		C1 - STACK 54pins																											
		J2	2 Analog A(F2)	4 Analog A(E1)	6 Analog A(D2)	8 Analog A(D4)	10 Analog A(B2)	12 Analog A(B4)	14 Analog A(A1)	16 Analog A(A3)	18 Analog A(C1)	20 Analog A(C3)	22 Analog A(F1)	24 Analog A(G2)	26 Analog A(I2)	28 Power VCC_SYS	30 Power VCC_SYS	32 Power VCC_SYS	34 Power VCC_SYS	36 Power VCC_SYS	38 Power VCC_SYS	40 Power VCC_SYS	42 Power VCC_SYS	44 Power VCC_SYS	46 Power VCC_SYS	48 Power VCC_SYS	50 Power VCC_SYS	52 Power VCC_SYS	54 Power VCC_SYS
	Sub system 2: EASIROC	P4	1 Power GND	3 Power GND	5 Power GND	7 Power GND	9 Power GND	11 Power GND	13 Power GND	15 Power GND	17 Power GND	19 Power GND	21 Power GND	23 Power GND	25 Power GND	27 Power GND	29 Power GND	31 Power GND	33 Power GND	35 Power GND	37 Power GND	39 Power GND	41 Power GND	43 Power GND	45 Power GND	47 Power GND	49 Power GND	51 Power GND	53 Power GND
		C2 - STACK PC104																											
		H2	2 Digital CS_A	4 Digital CS_B	6 Digital CS_C	8 Digital CS_D	10 Digital CS_E	12 Digital CS_F	14 Digital CS_G	16 Digital CS_H	18 Digital CS_I	20 Digital CS_J	22 Digital CS_K	24 Digital CS_L	26 Digital CS_M	28 Digital CS_N	30 Digital CS_O	32 Digital CS_P	34 Digital CS_Q	36 Digital CS_R	38 Digital CS_S	40 Digital CS_T	42 Digital CS_U	44 Digital CS_V	46 Digital CS_W	48 Digital CS_X	50 Digital CS_Y	52 Digital CS_Z	54 Digital CS_AA
		H1	1 Power*Charge VbatCH-	3 Power*Charge VbatCH-	5 Power*Charge VbatCH-	7 Power*Charge VbatCH-	9 Power*Charge VbatCH-	11 Power*Charge VbatCH-	13 Power*Charge VbatCH-	15 Power*Charge VbatCH-	17 Power*Charge VbatCH-	19 Power*Charge VbatCH-	21 Power*Charge VbatCH-	23 Power*Charge VbatCH-	25 Power*Charge VbatCH-	27 Power*Charge VbatCH-	29 Power*Charge VbatCH-	31 Power*Charge VbatCH-	33 Power*Charge VbatCH-	35 Power*Charge VbatCH-	37 Power*Charge VbatCH-	39 Power*Charge VbatCH-	41 Power*Charge VbatCH-	43 Power*Charge VbatCH-	45 Power*Charge VbatCH-	47 Power*Charge VbatCH-	49 Power*Charge VbatCH-	51 Power*Charge VbatCH-	53 Power*Charge VbatCH-
	Sub system 2: TRXVU	H2	2 Power*Charge VbatCH-	4 Power*Charge VbatCH-	6 Power*Charge VbatCH-	8 Power*Charge VbatCH-	10 Power*Charge VbatCH-	12 Power*Charge VbatCH-	14 Power*Charge VbatCH-	16 Power*Charge VbatCH-	18 Power*Charge VbatCH-	20 Power*Charge VbatCH-	22 Power*Charge VbatCH-	24 Power*Charge VbatCH-	26 Power*Charge VbatCH-	28 Power*Charge VbatCH-	30 Power*Charge VbatCH-	32 Power*Charge VbatCH-	34 Power*Charge VbatCH-	36 Power*Charge VbatCH-	38 Power*Charge VbatCH-	40 Power*Charge VbatCH-	42 Power*Charge VbatCH-	44 Power*Charge VbatCH-	46 Power*Charge VbatCH-	48 Power*Charge VbatCH-	50 Power*Charge VbatCH-	52 Power*Charge VbatCH-	54 Power*Charge VbatCH-
		C2 - STACK PC104																											
		H2	2 Power*Charge VbatCH-	4 Power*Charge VbatCH-	6 Power*Charge VbatCH-	8 Power*Charge VbatCH-	10 Power*Charge VbatCH-	12 Power*Charge VbatCH-	14 Power*Charge VbatCH-	16 Power*Charge VbatCH-	18 Power*Charge VbatCH-	20 Power*Charge VbatCH-	22 Power*Charge VbatCH-	24 Power*Charge VbatCH-	26 Power*Charge VbatCH-	28 Power*Charge VbatCH-	30 Power*Charge VbatCH-	32 Power*Charge VbatCH-	34 Power*Charge VbatCH-	36 Power*Charge VbatCH-	38 Power*Charge VbatCH-	40 Power*Charge VbatCH-	42 Power*Charge VbatCH-	44 Power*Charge VbatCH-	46 Power*Charge VbatCH-	48 Power*Charge VbatCH-	50 Power*Charge VbatCH-	52 Power*Charge VbatCH-	54 Power*Charge VbatCH-
		H1	1 Power*Charge VbatCH-	3 Power*Charge VbatCH-	5 Power*Charge VbatCH-	7 Power*Charge VbatCH-	9 Power*Charge VbatCH-	11 Power*Charge VbatCH-	13 Power*Charge VbatCH-	15 Power*Charge VbatCH-	17 Power*Charge VbatCH-	19 Power*Charge VbatCH-	21 Power*Charge VbatCH-	23 Power*Charge VbatCH-	25 Power*Charge VbatCH-	27 Power*Charge VbatCH-	29 Power*Charge VbatCH-	31 Power*Charge VbatCH-	33 Power*Charge VbatCH-	35 Power*Charge VbatCH-	37 Power*Charge VbatCH-	39 Power*Charge VbatCH-	41 Power*Charge VbatCH-	43 Power*Charge VbatCH-	45 Power*Charge VbatCH-	47 Power*Charge VbatCH-	49 Power*Charge VbatCH-	51 Power*Charge VbatCH-	53 Power*Charge VbatCH-

Figure 22.TOP cube stack connectors documentation

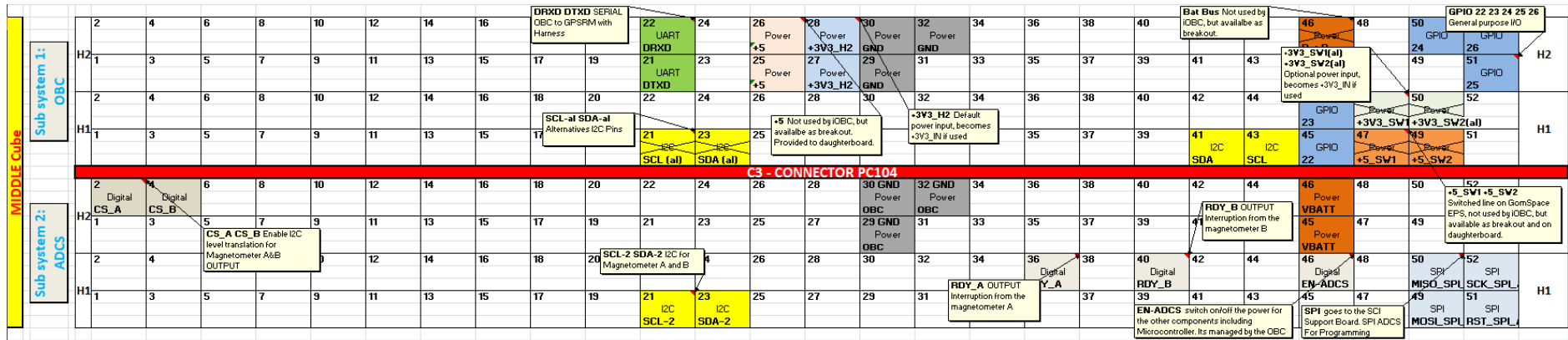
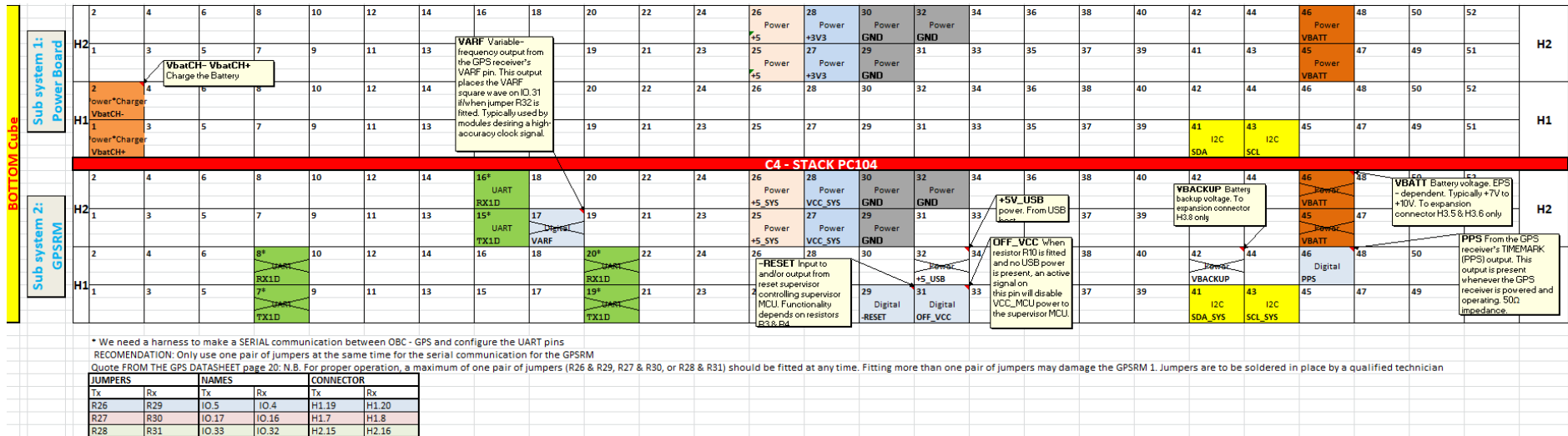

Figure 23. MIDDLE cube stack connectors documentation



7Figure 24. BOTTOM cube stack connectors documentation

3.2.2. Harnesses design.

The harnesses give us more flexibility to interconnect the different payloads, platforms, sensors, antennas and actuators in the flight segment of IGOSat. A harness is an assembly of electrical wires which transmit signals or electrical power between the ends.



Figure 25. Harness used for EPS testing

I choose the cable BS 3G 201 Type-A #28 AWG because it covers the current necessary to feed the payloads and the platforms and it has an aerospace standard so it is manufactured by many space companies.

The next figures present us each harness design and description in a document called “DOCUMENTATION OF WIRE(S) / HARNESS(ES)”, it contains the information related to the construction, fixation, location, connectors, wire distance, pin references, etc. Figure 20. shown us the complete interconnections diagram of the whole satellite, it is called “INTERCONNECTIONS DOCUMENTATION”.

													DOCUMENTATION OF WIRE(S) / HARNESS(ES)													Réf. : XXX-YY-NN Edition : 1 Date : XX-XX-XX Révision : 0 Date : XX-XX-XX Ionospheric and Gamma-ray Observations Satellite			
AUTOR: Juan VALVERDE SECTION: Electronics System Engineering DATE: 17/05/2019 DIAGRAM:													DESCRIPTION:				LABEL	Type	From				To						
													H1	Wires	SCI Detectors				SCI SupportBoard										
FROM				Fixation	HARNESS									Fixation	TO														
Subsystem	Reference	Pin	Label		Connector			Wire			Connector				Pin	Label	Reference	Subsystem											
SCI support board	J12	1	K (I2)	Solder + Adhesive + Heat Shrink Tubing	#Part	Pin	#Part Pin	#AWG	#Part	Color	Length	#Part Pin	Pin	#Part	1 (Index Mark)	K	SIPM - P6	Detector											
		2	A (I2)					28	BS 3G 210 -	Blue	35mm				2	A													
		3	K (I1)					28	BS 3G 210 -	Brown	35mm				1 (Index Mark)	K	SIPM - P11												
	90120-0764	4	A (I1)					28	BS 3G 210 -	Red	35mm				2	A													

Figure 26. Documentation for the harness H1



													DOCUMENTATION OF WIRE(S) / HARNESS(ES)													Réf. : XXX-YY-NN Edition : 1 Date : XX-XX-XX Révision : 0 Date : XX-XX-XX Ionospheric and Gamma-ray Observations Satellite			
AUTOR: Juan VALVERDE SECTION: Electronics System Engineering DATE: 17/05/2019 DIAGRAM:													DESCRIPTION:				LABEL	Type	From				To						
													H2	Radio Freq.	TEL Communication Board				TEL Antenna Board										
FROM				Fixation	HARNESS									Fixation	TO														
Subsystem	Reference	Pin	Label		Connector			Wire			Connector				Pin	Label	Reference	Subsystem											
TEL	J2 - RX (VHF)	1-Center pin	RF in	PlugIn	MMCX - RF	1	ISIS	ISIS	#Part	Color	Length	ISIS	1	MMCX - RF	1-Center pin	RF out	J2	Antenna											
		2-Shield	GND		UHF/VHF	2	ISIS	ISIS			60 mm	ISIS	2	UHF/VHF	2-Shield	GND													
FROM				Fixation	HARNESS									Fixation	TO														
Subsystem	Reference	Pin	Label		Connector			Wire			Connector				Pin	Label	Reference	Subsystem											
TEL	J3 - TX (UHF)	1-Center pin	RF out	PlugIn	MMCX - RF	1	ISIS	ISIS	#Part	Color	Length	ISIS	1	MMCX - RF	1-Center pin	RF in	J3	Antenna											
		2-Shield	GND		UHF/VHF	2	ISIS	ISIS			60 mm	ISIS	2	UHF/VHF	2-Shield	GND													

Figure 27. Documentation for the harness H2

													DOCUMENTATION OF WIRE(S) / HARNESS(ES)													Réf : XXX-YY-NN Edition : 1 Date : XX-XX-XX Révision : 0 Date : XX-XX-XX Ionospheric and Gamma-ray Observations Satellite																			
AUTOR: Juan VALVERDE SECTION: Electronics System Engineering DATE: 24/07/2019													DESCRIPTION:													<table border="1"> <thead> <tr> <th colspan="4">HARNESSES</th> </tr> <tr> <th>LABEL</th> <th>Type</th> <th>From</th> <th>To</th> </tr> </thead> <tbody> <tr> <td>H3</td> <td>Wires</td> <td>U2</td> <td>TEL Antenna Board</td> </tr> <tr> <td>H4</td> <td>Wires</td> <td>U2</td> <td>U1</td> </tr> </tbody> </table>				HARNESSES				LABEL	Type	From	To	H3	Wires	U2	TEL Antenna Board	H4	Wires	U2	U1
HARNESSES																																													
LABEL	Type	From	To																																										
H3	Wires	U2	TEL Antenna Board																																										
H4	Wires	U2	U1																																										
DIAGRAM:																																													
FROM				Fixation	HARNESS										Fixation	TO																													
Coupler / Board	Reference	Pin	Label		Connector			Wire				Connector				Pin	Label	Reference	Coupler / Board																										
U2	M80-5002405	1	VbatCH+	PlugIn + Jackscrews	H4	M80-4612405	1	Crimp Cont	28	BS 3G 210 T	Black	TBD	Crimp Cont	1	H4	M80-4612405	PlugIn + Jackscrews	1	VbatCH+	J1	M80-5002405	U1																							
		2	VbatCH-				2	Crimp Cont	28	BS 3G 210 T	Blue	TBD	Crimp Cont	2				2	VbatCH-																										
		3	SCL-2				3	Crimp Cont	28	BS 3G 210 T	Brown	TBD	Crimp Cont	3				3	SCL-2																										
		4	SDA-2				4	Crimp Cont	28	BS 3G 210 T	Red	TBD	Crimp Cont	4				4	SDA-2																										
		5	RDY_A				5	Crimp Cont	28	BS 3G 210 T	White	TBD	Crimp Cont	5				5	RDY_A																										
		6	RDY_B				6	Crimp Cont	28	BS 3G 210 T	Grey	TBD	Crimp Cont	6				6	RDY_B																										
		7	SDA-1				7	Crimp Cont	28	BS 3G 210 T	Violet	TBD	Crimp Cont	7				7	SDA-1																										
		8	SCL-1				8	Crimp Cont	28	BS 3G 210 T	Pink	TBD	Crimp Cont	8				8	SCL-1																										
		9	MOSI_SPI_A				9	Crimp Cont	28	BS 3G 210 T	Orange	TBD	Crimp Cont	9				9	MOSI_SPI_A																										
		10	MISO_SPI_A				10	Crimp Cont	28	BS 3G 210 T	Yellow	TBD	Crimp Cont	10				10	MISO_SPI_A																										
		11	RTS_SPI_AD				11	Crimp Cont	28	BS 3G 210 T	Green	TBD	Crimp Cont	11				11	RTS_SPI_AD																										
		12	SCK_SPI_AD				12	Crimp Cont	28	BS 3G 210 T	Green/Yell	TBD	Crimp Cont	12				12	SCK_SPI_AD																										
		13					13	Crimp Contact					Crimp Cont	13				13																											
		14					14	Crimp Contact					Crimp Cont	14				14																											
		15	CS_A				15	Crimp Cont	28	BS 3G 210 T	Black	TBD	Crimp Cont	15				15	CS_A																										
		16	CS_B				16	Crimp Cont	28	BS 3G 210 T	Blue	TBD	Crimp Cont	16				16	CS_B																										
		17	3,3V_1				17	Crimp Cont	28	BS 3G 210 T	Brown	TBD	Crimp Cont	17				17	3,3V_1																										
		18	3,3V_2				18	Crimp Cont	28	BS 3G 210 T	Red	TBD	Crimp Cont	18				18	3,3V_2																										
		19	GND_1				19	Crimp Cont	28	BS 3G 210 T	White	TBD	Crimp Cont	19				19	GND_1																										
		20	GND_2				20	Crimp Cont	28	BS 3G 210 T	Grey	TBD	Crimp Cont	20				20	GND_2																										
		21	GND_3				21	Crimp Cont	28	BS 3G 210 T	Violet	TBD	Crimp Cont	21				21	GND_3																										
		22	Bat Bus_1				22	Crimp Cont	28	BS 3G 210 T	Pink	TBD	Crimp Cont	22				22	Bat Bus_1																										
		23	Bat Bus_2				23	Crimp Cont	28	BS 3G 210 T	Orange	TBD	Crimp Cont	23				23	Bat Bus_2																										
		24	EN_SCI				24	Crimp Cont	28	BS 3G 210 T	Yellow	TBD	Crimp Cont	24				24	EN_SCI																										

FROM				Fixation	HARNESS										Fixation	TO							
Coupler / Board	Reference	Pin	Label		#Part	Pin	#Part Pin	#AWG	#Part	Color	Length	#Part Pin	Pin	#Part		Pin	Label	Reference	Coupler / Board				
U2	M80-5001005	1	3,3V_1	PlugIn + Jackscrews	H3	M80-4611005	1	Crimp Cont	28	BS 3G 210 T	Green	TBD	rimp Cont	1	H3	A28000-009	PlugIn + Jackscrews	1	Vcc	J1	Omnetics 9 pins	A29100-009	TEL Antenna
		2	SDA-1				2	Crimp Cont	28	BS 3G 210 T	Green/Yell	TBD	rimp Cont	2				2	SDA_A				
		3	GND_1				3	Crimp Cont	28	BS 3G 210 T	Black	TBD	rimp Cont	3				3	GND				
		4					4	Crimp Contact					Crimp Cont	4				4	SDA_B				
		5	GND_2				5	Crimp Cont	28	BS 3G 210 T	Blue	TBD	rimp Cont	5				5	GND				
		6	3,3V_2				6	Crimp Cont	28	BS 3G 210 T	Brown	TBD	rimp Cont	6				6	Vcc				
		7	SCL-1				7	Crimp Cont	28	BS 3G 210 T	Red	TBD	rimp Cont	7				7	SCL_A				
		8					8	Crimp Contact					Crimp Cont	8				8	SCL_B				
		9	GND_3				9	Crimp Cont	28	BS 3G 210 T	White	TBD	rimp Cont	7				9	GND				
		10					10	Crimp Contact					Crimp Cont	8									

Figure 28. Documentation for the harness H3H4

															DOCUMENTATION OF WIRE(S) / HARNESS(ES)															Réf. : XXX-YY-NN Edition : 1 Date : XX-XX-XX Révision : 0 Date : XX-XX-XX Ionospheric and Gamma-ray Observations Satellite															
AUTOR: Juan VALVERDE SECTION: Electronics System Engineering DATE: 17/05/2019															DESCRIPTION:															<table border="1"> <tr> <th colspan="4">HARNESSES</th> </tr> <tr> <th>LABEL</th> <th>Type</th> <th>From</th> <th>To</th> </tr> <tr> <td>H5</td> <td>Wires</td> <td>FM DaughterBoard</td> <td>ADCS Board</td> </tr> </table>				HARNESSES				LABEL	Type	From	To	H5	Wires	FM DaughterBoard	ADCS Board
HARNESSES																																													
LABEL	Type	From	To																																										
H5	Wires	FM DaughterBoard	ADCS Board																																										
DIAGRAM:																																													
FROM				Fixation	HARNESS									Fixation	TO																														
Coupler / Subsystem	Reference	Pin	Label		Connector			Wire			Connector				Pin	Label	Reference	Coupler / Subsystem																											
				#Part	Pin	#Part Pin	#AWG	#Part	Color	Length	#Part Pin	Pin	#Part																																
FM Daughter Board	Conn - J5 Harwin M80-8513442	1	GND	M80 - 8883405	1	Crimp Contact							TBD	PlugIn																															
		2	AIN0		2	Crimp Contact																																							
		3	AIN1		3	Crimp Contact																																							
		4	AIN2		4	Crimp Contact																																							
		5	AIN3		5	Crimp Contact																																							
		6	GND		6	Crimp Contact																																							
		7	AIN4		7	Crimp Contact																																							
		8	AIN5		8	Crimp Contact																																							
		9	AIN6		9	Crimp Contact																																							
		10	AIN7		10	Crimp Contact																																							
		11	GND		11	Crimp Contact																																							
		12	SPI1_NPCS0		12	Crimp Contact																																							
		13	SPI1_NPCS1		13	Crimp Contact																																							
		14	SPI1_NPCS2		14	Crimp Contact																																							
		15	GND		15	Crimp Contact																																							
		16	SPI1_SPCK		16	Crimp Cont	28	BS 3G 210 T	Black	35mm	Crimp Conta						1			1	SPI_SPCK																								
		17	SPI1_MOSI		17	Crimp Cont	28	BS 3G 210 T	Blue	35mm	Crimp Conta						2			2	SPI_MOSI																								
		18	SPI1_MISO		18	Crimp Cont	28	BS 3G 210 T	Brown	35mm	Crimp Conta						3			3	SPI_MISO																								
		19	GND		19	Crimp Contact																																							
		20	GPIO0/D8		20	Crimp Contact																																							
		21	GPIO1/D9		21	Crimp Contact																																							
		22	GPIO2/D10		22	Crimp Contact																																							
		23	GPIO3/D11		23	Crimp Contact																																							
		24	GND		24	Crimp Contact																																							
		25	GPIO4/D0		25	Crimp Contact																																							
		26	GPIO5/D1		26	Crimp Contact																																							
		27	GPIO6/D2		27	Crimp Contact																																							
		28	GPIO7/D3		28	Crimp Contact																																							
		29	GND		29	Crimp Contact																																							
		30	GPIO8/D4		30	Crimp Contact																																							
		31	GPIO9/D5		31	Crimp Contact																																							
		32	GPIO10/D6		32	Crimp Contact																																							
		33	GPIO11/D7		33	Crimp Contact																																							
		34	+3V3_SENS		34	Crimp Contact																																							

Figure 29. Documentation for the harness H5

										DOCUMENTATION OF WIRE(S) / HARNESS(ES)										Réf. : XXX-YY-NN Edition : 1 Date : XX-XX-XX Révision : 0 Date : XX-XX-XX Ionospheric and Gamma-ray Observations Satellite																																																																																																																																																																																																																																																																	
AUTOR: Juan VALVERDE SECTION: Electronics System Engineering DATE: 24/07/2019										DESCRIPTION:										<table border="1" style="width: 100%; text-align: center;"> <tr> <th colspan="4">HARNESSES</th> </tr> <tr> <th>LABEL</th> <th>Type</th> <th>From</th> <th>To</th> </tr> <tr> <td>H6</td> <td>Wires</td> <td>U3</td> <td>U4</td> </tr> </table>				HARNESSES				LABEL	Type	From	To	H6	Wires	U3	U4																																																																																																																																																																																																																																																		
HARNESSES																																																																																																																																																																																																																																																																																					
LABEL	Type	From	To																																																																																																																																																																																																																																																																																		
H6	Wires	U3	U4																																																																																																																																																																																																																																																																																		
DIAGRAM:										<table border="1" style="width: 100%; text-align: center;"> <tr> <th colspan="10">FROM</th> <th colspan="10">HARNESS</th> <th colspan="4">TO</th> </tr> <tr> <th colspan="4">Coupler / Subsystem</th> <th colspan="6">Reference</th> <th colspan="2">Fixation</th> <th colspan="2">Connector</th> <th colspan="6">Wire</th> <th colspan="2">Connector</th> <th colspan="2">Fixation</th> <th colspan="2">Reference</th> <th colspan="2">Coupler / Subsystem</th> </tr> <tr> <th>#Part</th> <th>Pin</th> <th>#Part</th> <th>Pin</th> <th>#AWG</th> <th>#Part</th> <th>Color</th> <th>Length</th> <th>#Part</th> <th>Pin</th> <th>#Part</th> <th>Pin</th> <th>#Part</th> <th>Pin</th> <th>Pin</th> <th>Label</th> <th>Reference</th> <th>Coupler / Subsystem</th> </tr> </table>										FROM										HARNESS										TO				Coupler / Subsystem				Reference						Fixation		Connector		Wire						Connector		Fixation		Reference		Coupler / Subsystem		#Part	Pin	#Part	Pin	#AWG	#Part	Color	Length	#Part	Pin	#Part	Pin	#Part	Pin	Pin	Label	Reference	Coupler / Subsystem																																																																																																																																																																																												
FROM										HARNESS										TO																																																																																																																																																																																																																																																																	
Coupler / Subsystem				Reference						Fixation		Connector		Wire						Connector		Fixation		Reference		Coupler / Subsystem																																																																																																																																																																																																																																																											
#Part	Pin	#Part	Pin	#AWG	#Part	Color	Length	#Part	Pin	#Part	Pin	#Part	Pin	Pin	Label	Reference	Coupler / Subsystem																																																																																																																																																																																																																																																																				
U3 M80-5012005 J1				M80-5012005 J1 1 VbatCH+ 2 VbatCH- 3 SDA 4 SCL 5 GPIO22 6 7 8 DTXD 9 DRXD 10 5V_1 11 5V_2 12 3,3V_1 13 3,3V_2 14 GND_1 15 GND_2 16 GND_3 17 Bat Bus_1 18 Bat Bus_2 19 GPIO24 20 GPIO25						Plugin + Jackscrews		M80-4612005		<table border="1" style="width: 100%; text-align: center;"> <tr> <th>#Part</th> <th>Pin</th> <th>#Part</th> <th>Pin</th> <th>#AWG</th> <th>#Part</th> <th>Color</th> <th>Length</th> <th>#Part</th> <th>Pin</th> <th>#Part</th> <th>Pin</th> </tr> <tr> <td>1</td> <td>1</td> <td>Crimp Conta</td> <td>28</td> <td>BS 3G 210 Ty</td> <td>Black</td> <td>TBD</td> <td></td> <td>Crimp Conta</td> <td>1</td> <td></td> <td></td> </tr> <tr> <td>2</td> <td>2</td> <td>Crimp Conta</td> <td>28</td> <td>BS 3G 210 Ty</td> <td>Blue</td> <td>TBD</td> <td></td> <td>Crimp Conta</td> <td>2</td> <td></td> <td></td> </tr> <tr> <td>3</td> <td>3</td> <td>Crimp Conta</td> <td>28</td> <td>BS 3G 210 Ty</td> <td>Brown</td> <td>TBD</td> <td></td> <td>Crimp Conta</td> <td>3</td> <td></td> <td></td> </tr> <tr> <td>4</td> <td>4</td> <td>Crimp Conta</td> <td>28</td> <td>BS 3G 210 Ty</td> <td>Red</td> <td>TBD</td> <td></td> <td>Crimp Conta</td> <td>4</td> <td></td> <td></td> </tr> <tr> <td>5</td> <td>5</td> <td>Crimp Conta</td> <td>28</td> <td>BS 3G 210 Ty</td> <td>White</td> <td>TBD</td> <td></td> <td>Crimp Conta</td> <td>5</td> <td></td> <td></td> </tr> <tr> <td>6</td> <td>6</td> <td>Crimp Contact</td> <td></td> <td></td> <td></td> <td></td> <td></td> <td>Crimp Conta</td> <td>6</td> <td></td> <td></td> </tr> <tr> <td>7</td> <td>7</td> <td>Crimp Contact</td> <td></td> <td></td> <td></td> <td></td> <td></td> <td>Crimp Conta</td> <td>7</td> <td></td> <td></td> </tr> <tr> <td>8</td> <td>8</td> <td>Crimp Conta</td> <td>28</td> <td>BS 3G 210 Ty</td> <td>Grey</td> <td>TBD</td> <td></td> <td>Crimp Conta</td> <td>8</td> <td></td> <td></td> </tr> <tr> <td>9</td> <td>9</td> <td>Crimp Conta</td> <td>28</td> <td>BS 3G 210 Ty</td> <td>Violet</td> <td>TBD</td> <td></td> <td>Crimp Conta</td> <td>9</td> <td></td> <td></td> </tr> <tr> <td>10</td> <td>10</td> <td>Crimp Conta</td> <td>28</td> <td>BS 3G 210 Ty</td> <td>Pink</td> <td>TBD</td> <td></td> <td>Crimp Conta</td> <td>10</td> <td></td> <td></td> </tr> <tr> <td>11</td> <td>11</td> <td>Crimp Conta</td> <td>28</td> <td>BS 3G 210 Ty</td> <td>Orange</td> <td>TBD</td> <td></td> <td>Crimp Conta</td> <td>11</td> <td></td> <td></td> </tr> <tr> <td>12</td> <td>12</td> <td>Crimp Conta</td> <td>28</td> <td>BS 3G 210 Ty</td> <td>Yellow</td> <td>TBD</td> <td></td> <td>Crimp Conta</td> <td>12</td> <td></td> <td></td> </tr> <tr> <td>13</td> <td>13</td> <td>Crimp Conta</td> <td>28</td> <td>BS 3G 210 Ty</td> <td>Green</td> <td>TBD</td> <td></td> <td>Crimp Conta</td> <td>13</td> <td></td> <td></td> </tr> <tr> <td>14</td> <td>14</td> <td>Crimp Conta</td> <td>28</td> <td>BS 3G 210 Ty</td> <td>Green/Yello</td> <td>TBD</td> <td></td> <td>Crimp Conta</td> <td>14</td> <td></td> <td></td> </tr> <tr> <td>15</td> <td>15</td> <td>Crimp Conta</td> <td>28</td> <td>BS 3G 210 Ty</td> <td>Black</td> <td>TBD</td> <td></td> <td>Crimp Conta</td> <td>15</td> <td></td> <td></td> </tr> <tr> <td>16</td> <td>16</td> <td>Crimp Conta</td> <td>28</td> <td>BS 3G 210 Ty</td> <td>Blue</td> <td>TBD</td> <td></td> <td>Crimp Conta</td> <td>16</td> <td></td> <td></td> </tr> <tr> <td>17</td> <td>17</td> <td>Crimp Conta</td> <td>28</td> <td>BS 3G 210 Ty</td> <td>Brown</td> <td>TBD</td> <td></td> <td>Crimp Conta</td> <td>17</td> <td></td> <td></td> </tr> <tr> <td>18</td> <td>18</td> <td>Crimp Conta</td> <td>28</td> <td>BS 3G 210 Ty</td> <td>Red</td> <td>TBD</td> <td></td> <td>Crimp Conta</td> <td>18</td> <td></td> <td></td> </tr> <tr> <td>19</td> <td>19</td> <td>Crimp Conta</td> <td>28</td> <td>BS 3G 210 Ty</td> <td>White</td> <td>TBD</td> <td></td> <td>Crimp Conta</td> <td>19</td> <td></td> <td></td> </tr> <tr> <td>24</td> <td>24</td> <td>Crimp Conta</td> <td>28</td> <td>BS 3G 210 Ty</td> <td>Grey</td> <td>TBD</td> <td></td> <td>Crimp Conta</td> <td>24</td> <td></td> <td></td> </tr> </table>						#Part	Pin	#Part	Pin	#AWG	#Part	Color	Length	#Part	Pin	#Part	Pin	1	1	Crimp Conta	28	BS 3G 210 Ty	Black	TBD		Crimp Conta	1			2	2	Crimp Conta	28	BS 3G 210 Ty	Blue	TBD		Crimp Conta	2			3	3	Crimp Conta	28	BS 3G 210 Ty	Brown	TBD		Crimp Conta	3			4	4	Crimp Conta	28	BS 3G 210 Ty	Red	TBD		Crimp Conta	4			5	5	Crimp Conta	28	BS 3G 210 Ty	White	TBD		Crimp Conta	5			6	6	Crimp Contact						Crimp Conta	6			7	7	Crimp Contact						Crimp Conta	7			8	8	Crimp Conta	28	BS 3G 210 Ty	Grey	TBD		Crimp Conta	8			9	9	Crimp Conta	28	BS 3G 210 Ty	Violet	TBD		Crimp Conta	9			10	10	Crimp Conta	28	BS 3G 210 Ty	Pink	TBD		Crimp Conta	10			11	11	Crimp Conta	28	BS 3G 210 Ty	Orange	TBD		Crimp Conta	11			12	12	Crimp Conta	28	BS 3G 210 Ty	Yellow	TBD		Crimp Conta	12			13	13	Crimp Conta	28	BS 3G 210 Ty	Green	TBD		Crimp Conta	13			14	14	Crimp Conta	28	BS 3G 210 Ty	Green/Yello	TBD		Crimp Conta	14			15	15	Crimp Conta	28	BS 3G 210 Ty	Black	TBD		Crimp Conta	15			16	16	Crimp Conta	28	BS 3G 210 Ty	Blue	TBD		Crimp Conta	16			17	17	Crimp Conta	28	BS 3G 210 Ty	Brown	TBD		Crimp Conta	17			18	18	Crimp Conta	28	BS 3G 210 Ty	Red	TBD		Crimp Conta	18			19	19	Crimp Conta	28	BS 3G 210 Ty	White	TBD		Crimp Conta	19			24	24	Crimp Conta	28	BS 3G 210 Ty	Grey	TBD		Crimp Conta	24			M80-4612005 J1 1 VbatCH+ 2 VbatCH- 3 SDA 4 SCL 5 -RESET 6 7 8 RX1D 9 TX1D 10 5V_1 11 5V_2 12 3,3V_1 13 3,3V_2 14 GND_1 15 GND_2 16 GND_3 17 Bat Bus_1 18 Bat Bus_2 19 OFF_VCC 20 PPS		Plugin + Jackscrews		M80-5012005 J1 U4	
																				#Part	Pin	#Part	Pin	#AWG	#Part	Color	Length	#Part	Pin	#Part	Pin																																																																																																																																																																																																																																																						
																				1	1	Crimp Conta	28	BS 3G 210 Ty	Black	TBD		Crimp Conta	1																																																																																																																																																																																																																																																								
																				2	2	Crimp Conta	28	BS 3G 210 Ty	Blue	TBD		Crimp Conta	2																																																																																																																																																																																																																																																								
																				3	3	Crimp Conta	28	BS 3G 210 Ty	Brown	TBD		Crimp Conta	3																																																																																																																																																																																																																																																								
																				4	4	Crimp Conta	28	BS 3G 210 Ty	Red	TBD		Crimp Conta	4																																																																																																																																																																																																																																																								
																				5	5	Crimp Conta	28	BS 3G 210 Ty	White	TBD		Crimp Conta	5																																																																																																																																																																																																																																																								
																				6	6	Crimp Contact						Crimp Conta	6																																																																																																																																																																																																																																																								
																				7	7	Crimp Contact						Crimp Conta	7																																																																																																																																																																																																																																																								
																				8	8	Crimp Conta	28	BS 3G 210 Ty	Grey	TBD		Crimp Conta	8																																																																																																																																																																																																																																																								
																				9	9	Crimp Conta	28	BS 3G 210 Ty	Violet	TBD		Crimp Conta	9																																																																																																																																																																																																																																																								
																				10	10	Crimp Conta	28	BS 3G 210 Ty	Pink	TBD		Crimp Conta	10																																																																																																																																																																																																																																																								
																				11	11	Crimp Conta	28	BS 3G 210 Ty	Orange	TBD		Crimp Conta	11																																																																																																																																																																																																																																																								
																				12	12	Crimp Conta	28	BS 3G 210 Ty	Yellow	TBD		Crimp Conta	12																																																																																																																																																																																																																																																								
																				13	13	Crimp Conta	28	BS 3G 210 Ty	Green	TBD		Crimp Conta	13																																																																																																																																																																																																																																																								
																				14	14	Crimp Conta	28	BS 3G 210 Ty	Green/Yello	TBD		Crimp Conta	14																																																																																																																																																																																																																																																								
																				15	15	Crimp Conta	28	BS 3G 210 Ty	Black	TBD		Crimp Conta	15																																																																																																																																																																																																																																																								
																				16	16	Crimp Conta	28	BS 3G 210 Ty	Blue	TBD		Crimp Conta	16																																																																																																																																																																																																																																																								
																				17	17	Crimp Conta	28	BS 3G 210 Ty	Brown	TBD		Crimp Conta	17																																																																																																																																																																																																																																																								
																				18	18	Crimp Conta	28	BS 3G 210 Ty	Red	TBD		Crimp Conta	18																																																																																																																																																																																																																																																								
19	19	Crimp Conta	28	BS 3G 210 Ty	White	TBD		Crimp Conta	19																																																																																																																																																																																																																																																																												
24	24	Crimp Conta	28	BS 3G 210 Ty	Grey	TBD		Crimp Conta	24																																																																																																																																																																																																																																																																												

Figure 30. Documentation for the harness H6

				DOCUMENTATION OF WIRE(S) / HARNESS(ES)										Réf. : XXX-YY-NN Edition : 1 Date : XX-XX-XX Révision : 0 Date : XX-XX-XX Ionospheric and Gamma-ray Observations Satellite															
AUTOR: Juan VALVERDE SECTION: Electronics System Engineering DATE: 17/05/2019 DIAGRAM:				DESCRIPTION:										<table border="1" style="width: 100%; text-align: center;"> <tr> <th colspan="4">HARNESSES</th> </tr> <tr> <th>LABEL</th> <th>Type</th> <th>From</th> <th>To</th> </tr> <tr> <td>H7</td> <td>Wires</td> <td>Reaction Wheel</td> <td>ADCS Board</td> </tr> </table>				HARNESSES				LABEL	Type	From	To	H7	Wires	Reaction Wheel	ADCS Board
HARNESSES																													
LABEL	Type	From	To																										
H7	Wires	Reaction Wheel	ADCS Board																										
FROM				Fixation	HARNESS										Fixation	TO													
Coupler / Subsystem	Reference	Pin	Label		Connector			Wire				Connector				Pin	Label	Reference	Coupler / Subsystem										
					#Part	Pin	#Part Pin	#AWG	#Part	Color	Length	#Part Pin	Pin	#Part															
Reaction Wheel	CubeWheel connector Samtec TFM	1	PGND	Fixed							35mm	Crimp Conta	1	SFSDT-07-30 G-03.00-SS	Plugin	1	GND	J3	ADCS										
		2	PGND									35mm	Crimp Conta			2				2	GND								
		3	V_Bat									35mm	Crimp Conta			3				3	VBATT_PRO								
		4	V_Bat									35mm	Crimp Conta			4				4	VBATT_PRO								
		5	DGND									35mm	Crimp Conta			5				5	GND								
		6	3V3									35mm	Crimp Conta			6				6	.+3.3V								
		7	UART_TX									35mm	Crimp Conta			7				7	UART_TX								
		8	UART_RX									35mm	Crimp Conta			8				8	UART_RX								
		9	Enable									35mm	Crimp Conta			9				9	Enable								
		10	I2C_SCL									35mm	Crimp Conta			10				10	SCL								
		11	I2C_SDA									35mm	Crimp Conta			11				11	SDA								
		12	DGND									35mm	Crimp Conta			12				12	GND								
		13	CANH									35mm	Crimp Conta			13				13									
		14	CANL									35mm	Crimp Conta			14				14									

Figure 31. Documentation for the harness H7



										<p>DOCUMENTATION OF WIRE(S) / HARNESS(ES)</p>										<p>Réf. : XXX-YY-NN Edition : 1 Date : XX-XX-XX Révision : 0 Date : XX-XX-XX</p>											
<p>AUTOR: Juan VALVERDE SECTION: Electronics System Engineering DATE: 17/05/2019</p>										<p>DESCRIPTION: HARNESSES</p> <table border="1"> <tr> <th>LABEL</th> <th>Type</th> <th>From</th> <th>To</th> </tr> <tr> <td>H8</td> <td>Wires</td> <td>Solar Panels</td> <td>EPS Power Board</td> </tr> </table>										LABEL	Type	From	To	H8	Wires	Solar Panels	EPS Power Board	<p>Ionospheric and Gamma-ray Observations Satellite</p> 			
LABEL	Type	From	To																												
H8	Wires	Solar Panels	EPS Power Board																												
<p>DIAGRAM: </p>																															
FROM				Fixation	HARNESS										Fixation	TO															
Subsystem	Reference	Pin	Label		Connector		Wire				Connector		Pin	Label		Reference	Subsystem														
Solar Panels SP_Xsat+	J1 M80-5300642	1	SDA	PlugIn + Jackscrews	M80-4610642	1	Crimp Conta	28	BS 3G 210 Ty	Black	TBD	Crimp Conta	1	M80-4610642	PlugIn + Jackscrews	1	SDA	J1 M80-5300642	EPS Alimentation Board												
		2	3v3			2	Crimp Conta	28	BS 3G 210 Ty	Blue	TBD	Crimp Conta	2			2	3v3														
		3	SCL			3	Crimp Conta	28	BS 3G 210 Ty	Brown	TBD	Crimp Conta	3			3	SCL														
		4	GND			4	Crimp Conta	28	BS 3G 210 Ty	Red	TBD	Crimp Conta	4			4	GND														
		5	GND			5	Crimp Conta	28	BS 3G 210 Ty	White	TBD	Crimp Conta	5			5	GND														
		6	V_SP			6	Crimp Conta	28	BS 3G 210 Ty	Grey	TBD	Crimp Conta	6			6	V_SP														
FROM				Fixation	HARNESS										Fixation	TO															
Subsystem	Reference	Pin	Label		Connector		Wire				Connector		Pin	Label		Reference	Subsystem														
Solar Panels SP_Xsat+	J1 M80-5300642	1	SDA	PlugIn + Jackscrews	M80-4610642	1	Crimp Conta	28	BS 3G 210 Ty	Black	TBD	Crimp Conta	1	M80-4610642	PlugIn + Jackscrews	1	SDA	J8 M80-5300642	EPS Alimentation Board												
		2	3v3			2	Crimp Conta	28	BS 3G 210 Ty	Blue	TBD	Crimp Conta	2			2	3v3														
		3	SCL			3	Crimp Conta	28	BS 3G 210 Ty	Brown	TBD	Crimp Conta	3			3	SCL														
		4	GND			4	Crimp Conta	28	BS 3G 210 Ty	Red	TBD	Crimp Conta	4			4	GND														
		5	GND			5	Crimp Conta	28	BS 3G 210 Ty	White	TBD	Crimp Conta	5			5	GND														
		6	V_SP			6	Crimp Conta	28	BS 3G 210 Ty	Grey	TBD	Crimp Conta	6			6	V_SP														
FROM				Fixation	HARNESS										Fixation	TO															
Subsystem	Reference	Pin	Label		Connector		Wire				Connector		Pin	Label		Reference	Subsystem														
Solar Panels SP_Xsat+	J2 M80-5300642	1	SDA	PlugIn + Jackscrews	M80-4610642	1	Crimp Conta	28	BS 3G 210 Ty	Black	TBD	Crimp Conta	1	M80-4610642	PlugIn + Jackscrews	1	SDA	J9 M80-5300642	EPS Alimentation Board												
		2	3v3			2	Crimp Conta	28	BS 3G 210 Ty	Blue	TBD	Crimp Conta	2			2	3v3														
		3	SCL			3	Crimp Conta	28	BS 3G 210 Ty	Brown	TBD	Crimp Conta	3			3	SCL														
		4	GND			4	Crimp Conta	28	BS 3G 210 Ty	Red	TBD	Crimp Conta	4			4	GND														
		5	GND			5	Crimp Conta	28	BS 3G 210 Ty	White	TBD	Crimp Conta	5			5	GND														
		6	V_SP			6	Crimp Conta	28	BS 3G 210 Ty	Grey	TBD	Crimp Conta	6			6	V_SP														
FROM				Fixation	HARNESS										Fixation	TO															
Subsystem	Reference	Pin	Label		Connector		Wire				Connector		Pin	Label		Reference	Subsystem														
Solar Panels SP_Xsat+	J2 M80-5300642	1	SDA	PlugIn + Jackscrews	M80-4610642	1	Crimp Conta	28	BS 3G 210 Ty	Black	TBD	Crimp Conta	1	M80-4610642	PlugIn + Jackscrews	1	SDA	J10 M80-5300642	EPS Alimentation Board												
		2	3v3			2	Crimp Conta	28	BS 3G 210 Ty	Blue	TBD	Crimp Conta	2			2	3v3														
		3	SCL			3	Crimp Conta	28	BS 3G 210 Ty	Brown	TBD	Crimp Conta	3			3	SCL														
		4	GND			4	Crimp Conta	28	BS 3G 210 Ty	Red	TBD	Crimp Conta	4			4	GND														
		5	GND			5	Crimp Conta	28	BS 3G 210 Ty	White	TBD	Crimp Conta	5			5	GND														
		6	V_SP			6	Crimp Conta	28	BS 3G 210 Ty	Grey	TBD	Crimp Conta	6			6	V_SP														

Figure 32. Documentation for the harness H8







										<p>DOCUMENTATION OF WIRE(S) / HARNESS(ES)</p>										<p>Réf. : XXX-YY-NN Edition : 1 Date : XX-XX-XX Révision : 0 Date : XX-XX-XX</p>															
<p>AUTOR: Juan VALVERDE SECTION: Electronics System Engineering DATE: 17/05/2019</p>										<p>DESCRIPTION:</p> <table border="1" style="width: 100%; text-align: center;"> <tr> <th colspan="4">HARNESSES</th> </tr> <tr> <th>LABEL</th> <th>Type</th> <th>From</th> <th>To</th> </tr> <tr> <td>H9</td> <td>Wires</td> <td>Battery Board</td> <td>EPS Power Board</td> </tr> </table>										HARNESSES				LABEL	Type	From	To	H9	Wires	Battery Board	EPS Power Board	<p>Ionospheric and Gamma-ray Observations Satellite</p> 			
HARNESSES																																			
LABEL	Type	From	To																																
H9	Wires	Battery Board	EPS Power Board																																
<p>DIAGRAM:</p>																																			
FROM				Fixation	HARNESS										Fixation	TO																			
Subsystem	Reference	Pin	Label		Connector			Wire				Connector				Subsystem	Reference	Pin	Label																
Battery Board	Con-Battery1	1	VBATT-LOAD	PlugIn + Jackscrews 	#Part	Pin	#Part Pin	#AWG	#Part	Color	Length	#Part Pin	Pin	#Part	PlugIn + Jackscrews 	1	VBATT-LOAD	J16	EPS Alimentation Board																
		2	VBATT-LOAD		M80 - 4611242	1	Crimp Conta	28	BS 3G 210 Ty	Black	60mm	Crimp Conta	1	M80 - 4611242		2	VBATT-LOAD	M80-5301242 																	
		3	GND		2	Crimp Conta	28	BS 3G 210 Ty	Blue	60mm	60mm	Crimp Conta	2			3	GND																		
		4	GND		3	Crimp Conta	28	BS 3G 210 Ty	Brown	60mm	60mm	Crimp Conta	3			4	GND																		
	M80 - 5301242	5	3V3		4	Crimp Conta	28	BS 3G 210 Ty	Red	60mm	60mm	Crimp Conta	4			5	3V3																		
		6	3V3		5	Crimp Conta	28	BS 3G 210 Ty	White	60mm	60mm	Crimp Conta	5			6	3V3																		
		7	SCL		6	Crimp Conta	28	BS 3G 210 Ty	Grey	60mm	60mm	Crimp Conta	6			7	SCL																		
		8	SCL		7	Crimp Conta	28	BS 3G 210 Ty	Violet	60mm	60mm	Crimp Conta	7			8	SCL																		
		9	SDA		8	Crimp Conta	28	BS 3G 210 Ty	Pink	60mm	60mm	Crimp Conta	8			9	SDA																		
		10	SDA		9	Crimp Conta	28	BS 3G 210 Ty	Orange	60mm	60mm	Crimp Conta	9			10	SDA																		
		11	Chrg+		10	Crimp Conta	28	BS 3G 210 Ty	Yellow	60mm	60mm	Crimp Conta	10			11	Chrg+																		
		12	Chrg+		11	Crimp Conta	28	BS 3G 210 Ty	Green	60mm	60mm	Crimp Conta	11			12	Chrg+																		
				12	Crimp Conta	28	BS 3G 210 Ty	Green/Yello	60mm	60mm	Crimp Conta	12																							

Figure 33. Documentation for the harness H9

										DOCUMENTATION OF WIRE(S) / HARNESS(ES)										Réf. : XXX-YY-NN Edition : 1 Date : XX-XX-XX Révision : 0 Date : XX-XX-XX Ionospheric and Gamma-ray Observations Satellite															
AUTOR: Juan VALVERDE SECTION: Electronics System Engineering DATE: 17/05/2019										DESCRIPTION:										<table border="1"> <tr><th colspan="4">HARNESSES</th></tr> <tr><th>LABEL</th><th>Type</th><th>From</th><th>To</th></tr> <tr><td>H10</td><td>Radio Freq.</td><td>GPSRM Board</td><td>GPS Antenna</td></tr> </table>				HARNESSES				LABEL	Type	From	To	H10	Radio Freq.	GPSRM Board	GPS Antenna
HARNESSES																																			
LABEL	Type	From	To																																
H10	Radio Freq.	GPSRM Board	GPS Antenna																																
DIAGRAM:																																			
FROM				Fixation	HARNESS									Fixation	TO																				
Subsystem	Reference	Pin	Label		Connector			Wire			Connector				Pin	Label	Reference	Subsystem																	
				#Part	Pin	#Part Pin	#AWG	#Part	Color	Length	#Part Pin	Pin	#Part																						
GPSRM Board		1			1		Tallysman			40mm		1		PlugIn	1		GPS																		
		2			2		Tallysman			40mm		2		PlugIn	2		Antenna																		

Figure 34. Documentation for the harness H10

										DOCUMENTATION OF WIRE(S) / HARNESS(ES)										Réf. : XXX-YY-NN Edition : 1 Date : XX-XX-XX Révision : 0 Date : XX-XX-XX Ionospheric and Gamma-ray Observations Satellite															
AUTOR: Juan VALVERDE SECTION: Electronics System Engineering DATE: 17/05/2019										DESCRIPTION:										<table border="1"> <tr><th colspan="4">HARNESSES</th></tr> <tr><th>LABEL</th><th>Type</th><th>From</th><th>To</th></tr> <tr><td>H11</td><td>Wires</td><td>Battery Board</td><td>Kill-Switches</td></tr> </table>				HARNESSES				LABEL	Type	From	To	H11	Wires	Battery Board	Kill-Switches
HARNESSES																																			
LABEL	Type	From	To																																
H11	Wires	Battery Board	Kill-Switches																																
DIAGRAM:																																			
FROM				Fixation	HARNESS									Fixation	TO																				
Subsystem	Reference	Pin	Label		Connector			Wire			Connector				Pin	Label	Reference	Subsystem																	
				#Part	Pin	#Part Pin	#AWG	#Part	Color	Length	#Part Pin	Pin	#Part																						
Battery Board	KS2 - MOLEX 22032021	1	VBATT-LOAD	TBD	1		28	BS 3G 210 Ty	Black	90mm		1		Solder + Adhesive + Heat Shrink	1	Common	2																		
		2	Chrg+		2		28	BS 3G 210 Ty	Blue	90mm		2		Solder + Adhesive + Heat Shrink	2	NC	Kill Swich1																		
FROM				Fixation	HARNESS									Fixation	TO																				
Subsystem	Reference	Pin	Label		Connector			Wire			Connector				Pin	Label	Reference	Subsystem																	
				#Part	Pin	#Part Pin	#AWG	#Part	Color	Length	#Part Pin	Pin	#Part																						
Battery Board	KS2 - MOLEX 22032021	1	VBATT-LOAD	TBD	1		28	BS 3G 210 Ty	Black	90mm		1		Solder + Adhesive + Heat Shrink	1	Common	2																		
		2	Chrg+		2		28	BS 3G 210 Ty	Blue	90mm		2		Solder + Adhesive + Heat Shrink	2	NC	Kill Swich2																		

Figure 35. Documentation for the harness H11

				DOCUMENTATION OF WIRE(S) / HARNESS(ES)										Réf. : XXX-YY-NN Edition : 1 Date : XX-XX-XX Révision : 0 Date : XX-XX-XX																																																																																				
AUTOR: Juan VALVERDE SECTION: Electronics System Engineering DATE: 17/05/2019				DESCRIPTION:										<table border="1"> <tr> <th colspan="4">HARNESSES</th> </tr> <tr> <th>LABEL</th> <th>Type</th> <th>From</th> <th>To</th> </tr> <tr> <td>H12</td> <td>Wires</td> <td>Remove before flight</td> <td>EPS Battery Board</td> </tr> </table>		HARNESSES				LABEL	Type	From	To	H12	Wires	Remove before flight	EPS Battery Board																																																																							
HARNESSES																																																																																																		
LABEL	Type	From	To																																																																																															
H12	Wires	Remove before flight	EPS Battery Board																																																																																															
DIAGRAM:				<table border="1"> <thead> <tr> <th colspan="4">FROM</th> <th rowspan="3">Fixation</th> <th colspan="9">HARNESS</th> <th rowspan="3">Fixation</th> <th colspan="4">TO</th> </tr> <tr> <th rowspan="2">Subsystem</th> <th rowspan="2">Reference</th> <th rowspan="2">Pin</th> <th rowspan="2">Label</th> <th colspan="3">Connector</th> <th colspan="3">Wire</th> <th colspan="3">Connector</th> <th rowspan="2">Pin</th> <th rowspan="2">Label</th> <th rowspan="2">Reference</th> <th rowspan="2">Subsystem</th> </tr> <tr> <th>#Part</th> <th>Pin</th> <th>#Part Pin</th> <th>#AWG</th> <th>#Part</th> <th>Color</th> <th>Length</th> <th>#Part Pin</th> <th>Pin</th> <th>#Part</th> </tr> </thead> <tbody> <tr> <td rowspan="2">Battery Board</td> <td rowspan="2">RBF1-MOLEX 22032021</td> <td>1</td> <td>VBATT-LOAD</td> <td rowspan="2">Solder + Adhesive + Heat Shrink Tubing</td> <td rowspan="2">TBD</td> <td>1</td> <td></td> <td></td> <td>28</td> <td>BS 3G 210 Ty</td> <td>Black</td> <td>40mm</td> <td></td> <td></td> <td>1</td> <td rowspan="2">Solder + Adhesive + Heat Shrink Tubing</td> <td>1</td> <td>Common</td> <td rowspan="2">1</td> <td rowspan="2">RBF</td> </tr> <tr> <td>2</td> <td>VBATT-LOAD</td> <td>2</td> <td></td> <td></td> <td>28</td> <td>BS 3G 210 Ty</td> <td>Blue</td> <td>40mm</td> <td></td> <td></td> <td>2</td> <td>2</td> <td>NC</td> </tr> </tbody> </table>														FROM				Fixation	HARNESS									Fixation	TO				Subsystem	Reference	Pin	Label	Connector			Wire			Connector			Pin	Label	Reference	Subsystem	#Part	Pin	#Part Pin	#AWG	#Part	Color	Length	#Part Pin	Pin	#Part	Battery Board	RBF1-MOLEX 22032021	1	VBATT-LOAD	Solder + Adhesive + Heat Shrink Tubing	TBD	1			28	BS 3G 210 Ty	Black	40mm			1	Solder + Adhesive + Heat Shrink Tubing	1	Common	1	RBF	2	VBATT-LOAD	2			28	BS 3G 210 Ty	Blue	40mm			2	2	NC
FROM				Fixation	HARNESS									Fixation	TO																																																																																			
Subsystem	Reference	Pin	Label		Connector			Wire			Connector				Pin	Label	Reference	Subsystem																																																																																
					#Part	Pin	#Part Pin	#AWG	#Part	Color	Length	#Part Pin	Pin						#Part																																																																															
Battery Board	RBF1-MOLEX 22032021	1	VBATT-LOAD	Solder + Adhesive + Heat Shrink Tubing	TBD	1			28	BS 3G 210 Ty	Black	40mm			1	Solder + Adhesive + Heat Shrink Tubing	1	Common	1	RBF																																																																														
		2	VBATT-LOAD			2			28	BS 3G 210 Ty	Blue	40mm			2		2	NC																																																																																

Figure 36. Documentation for the harness H12

3.2.3. Couplers.

The coupler is a printed circuit board introduced to the IGOSat Flight model to interconnect the PC104 connector specification to a harness in the flight segment of IGOSat. A single pin in the couplers to connect a harness permit a current of 3A@25°C and 2.2A@85°C (HARWIN , 2019). The next figures present us a document called "DOCUMENTATION OF COUPLERS DESIGN", the document presents the PC104 information in the different payloads and platforms that helps us to choose the correct digital signals and electrical power signals to design the couplers.

										DOCUMENTATION OF COUPLERS DESIGN										Réf. : XXX-YY-NN Edition : 1 Date : XX-XX-XX Révision : 0 Date : XX-XX-XX	
AUTOR: Juan VALVERDE SECTION: Electronics System Engineering DATE: 17/05/2019										DESCRIPTION: Documentation that helps us to choose the correct signals and electrical power to design the couplers										Ionospheric and Gamma-ray Observations Satellite	
Sub System		INTERCONNECTION			Sub System					Sub System		INTERCONNECTION			Sub System						
TEL Board (connection with EASIROC Board)		from: U1_TEL to_OBC to:U2_OBC to:TEL			OBC (connection with ADCS)					TEL Board (connection with EASIROC Board)		from: U1_TEL to_OBC to:U2_OBC to:TEL			OBC (connection with ADCS)						
Reference	TEL	EASIROC	Pin	Antenna	Pin	OBC	ADCS	Reference	Reference	TEL	EASIROC	Pin	Antenna	Pin	OBC	ADCS	Reference				
J1-H1	VbatCH+		1	VbatCH+	1			J1-H1	J1-H2			1		1			J1-H2				
	VbatCH-		2	VbatCH-	2					CS_A		2	CS_A	2		CS_A					
			3		3							3			3						
			4		4								4	CS_B	4			CS_B			
			5		5								5		5						
			6		6								6		6						
			7		7								7		7						
			8		8								8		8						
			9		9								9		9						
			10		10								10		10						
			11		11								11		11						
			12		12								12		12						
			13		13								13		13						
			14		14								14		14						
			15		15								15		15						
			16		16								16		16						
			17		17								17		17						
			18		18								18		18						
			19		19								19		19						
			20		20								20		20						
		ALL	SCL-2	21	SCL-2	21	SCL			SCL-2			21		21						DTXD
		ALL	SDA-2	22	SDA-2	22	SDA			SDA-2			22		22						DRXD
				23		23							23		23						
				24		24							24		24						
				25		25							25		25						+5
				26		26							26		26						+5
				27		27							VCC_SYS	27	3.3V_1	3.3V_1		27			+3V3_H2
				28		28							VCC_SYS	28	3.3V_2	3.3V_2		28			+3V3_H2
				29		29							GND	29	GND_1	GND_1		29			GND
				30		30							GND	30	GND_2	GND_2		30			GND
				31		31							GND	31				31			GND
				32		32							GND	32	GND_3	GND_3		32			GND
			33		33					GND	33			33			GND				
			34		34					GND	34			34			GND				
			35		35						35			35							
		RDY_A	36	RDY_A	36		RDY_A				36			36							
			37		37						37			37							
			38		38						38			38							
			39		39						39			39							
		RDY_B	40	RDY_B	40		RDY_B				40			40							
	SDA	SDA-1	41	SDA-1	SDA-1	41	SDA				41			41							
			42			42					42			42							
	SCL	SCL-1	43	SCL-1	SCL-1	43	SCL				43			43							
	GPIO		44			44					44			44							
			45			45	GPIO 22				45			45			BatBus VBATT				
			46			46	GPIO 23	EN-ADCS			46			46			BatBus VBATT				
			47			47	GPIO 24				47			47			BatBus VBATT				
			48			48	GPIO 25				48			48							
			49			49	GPIO 26				49			49							
		MOSI_SPI_A	49	OSI_SPI_ADCS		49	GPIO 27	MOSI_SPI_A			49			49							
		MISO_SPI_A	50	SO_SPI_ADCS		50	GPIO 28	MISO_SPI_A			50			50			GPIO 24				
		RTS_SPI_AD	51	TS_SPI_ADCS		51	GPIO 29	RTS_SPI_AD			51			51			GPIO 25				
		CS_SPI_ADC	52	S_SPI_ADCS		52	GPIO 30	SCK_SPI_AD			52			52			GPIO 26				

Figure 37. PC104 Documentation to design the coupler U1_TEL_to_OBC and U2_OBC_to_TEL

Sub System				INTERCONNECTION		Sub System			
ADCS Board (connection with OBC Board)				from: U3_ADCS_1 to: U4_EPS_10	EPS (connection with GPSRM)				
Reference	ADCS	OBC	Pin	Pin	EPS	GPSRM	Reference		
J1-H1			1	VbatCH+	1	VbatCH+	J1-H1		
			2	VbatCH-	2	VbatCH-			
			3		3				
			4		4				
			5		5				
			6		6				
			7		7	TX1D			
			8		8	RX1D			
			9		9				
			10		10				
			11		11				
			12		12				
			13		13				
			14		14				
			15		15				
			16		16				
			17		17				
			18		18				
			19		19	TX1D			
			20		20	RX1D			
SCL-2	SCL-2		21		21				
			22		22				
SDA-2	SDA-2		23		23				
			24		24				
			25		25				
			26		26				
			27		27				
			28		28				
			29		29	-RESET			
			30		30				
			31		31	OFF_VCC			
			32		32				
			33		33				
			34		34				
			35		35				
RDY_A			36		36				
			37		37				
			38		38				
			39		39				
RDY_B			40		40				
	SDA		41	SDA	41	SDA_SYS			
			42		42				
	SCL		43	SCL	43	SCL_SYS			
			44		44				
EN-ADCS	GPIO 22		45	GPIO 22	-RESET	45			
	GPIO 23		46		46	PPS			
			47		47				
			48		48				
			49		49				
MOSI_SPI			50		50				
MISO_SPI			51		51				
RTS_SPI_ADCS			51		51				
SCK_SPI_ADCS			52		52				

Sub System				INTERCONNECTION		Sub System			
ADCS Board (connection with OBC Board)				from: U3_ADCS_1 to: U4_EPS_10	EPS (connection with GPSRM)				
Reference	ADCS	OBC	Pin	Pin	EPS	GPSRM	Reference		
J1-H2			1		1		J1-H2		
	CS_A		2		2				
			3		3				
	CS_B		4		4				
			5		5				
			6		6				
			7		7				
			8		8				
			9		9				
			10		10				
			11		11				
			12		12				
			13		13				
			14		14				
			15		15				
			16		16				
			17		17	VARF			
			18		18				
			19		19				
			20		20				
			21	DTXD	DTXD	RX1D	16	RX1D	
			22	DRXD	DRXD	TX1D	15	TX1D	
			23		23				
			24		24				
			25	5V_1	25	5V_1	45	5V_SYS	
			26	5V_2	26	5V_2	45	5V_SYS	
			27	3.3V_1	27	3.3V_1	45	VCC_SYS	
			28	3.3V_2	28	3.3V_2	45	VCC_SYS	
			29	GND_1	29	GND_1	45	GND	
			30	GND_2	30	GND_2	45	GND	
			31		31				
			32	GND_3	32	GND_3	45	GND	
			33		33				
			34		34				
			35		35				
			36		36				
			37		37				
			38		38				
			39		39				
			40		40				
			41		41				
			42		42				
			43		43				
			44		44				
Bat Bus	BatBus		45	BatBus_1	45	VBATT	BatBus		
Bat Bus	BatBus		46	BatBus_2	46	VBATT	BatBus		
			47		47				
			48		48				
			49		49				
			50	GPIO 24	GPIO 24	OFF_VCC	50		
			51	GPIO 25	GPIO 25	PPS	51		
			52		52				

Figure 38. PC104 Documentation to design the coupler U3_ADCS_to_EPS and U4_EPS_to_ADACS

After that, I used the documentation and the KiCAD software to design the different couplers. I choose the connectors with the series M80 – 853 XX 42 for vertical type and M80 – 851 XX 42 for horizontal type from HARWIN, these connectors even if they do not have space certification, these connectors are the best option for our application because nano-Sats do not require the same level quality than standard space mission because we do not have the same funding and because the mission duration is very much shorter so they are widely used in CubeSats. For the PC104 EPS connector standard, I chose the connectors that meet the electrical, electronic and mechanic requirements.

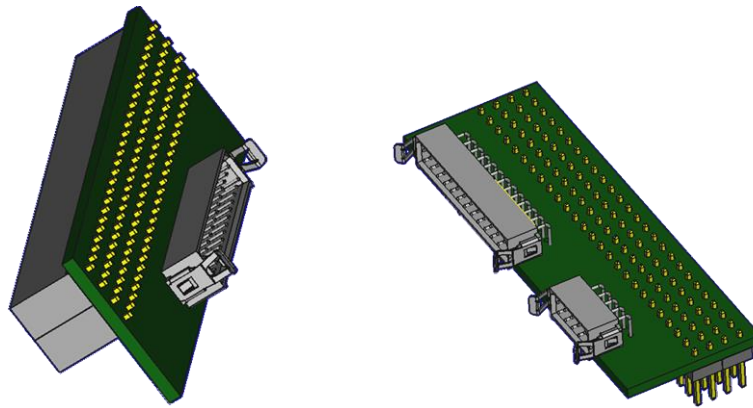

Figure 39. Coupler U1_TEL_to_OBC (left) and U2_OBC_to_TEL (right)

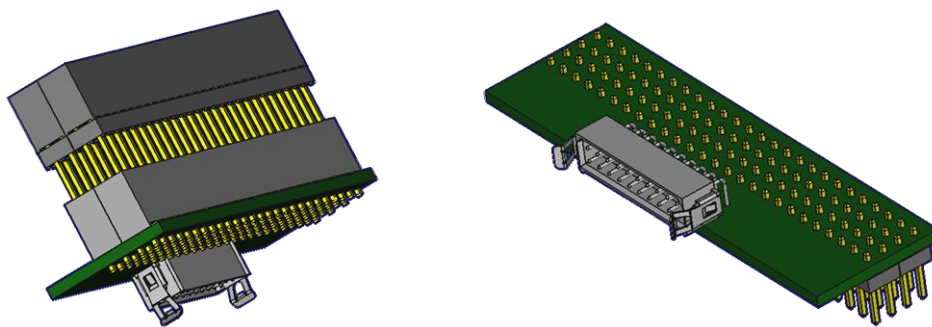

Figure 40. Coupler U3_ADCS_to_EPS (left) and U4_EPS_to_ADCS (right)

3.3 Assembly, integration, and testing.

The AIT Procedure (Assembly, Integration and Testing Procedure) provides information with definition documents and testing proposal optimized to be applied to track the testing procedure of IGOSat along with providing the base for quality controlling sub-systems validation and corresponding progress.

The system will go through the Functional Engineering Model Test, also referred to as Flat-Sat that provides a base platform for system integration, connecting IGOSat as an assembly for validating, troubleshoot and validate the functionality of the system before the final integration on the Flight Model.

The AIT has divided the testing procedure to surround the two most important flight

supporting equipment on-board, the OBC – On-Board Computer, and the EPS – Electronic Power System. Considered to be the “heart and brain” of the satellite, processing data and providing electrical power to the entire system. The OBC and EPS will act as a master hub, where other subsystems will subsequently be added to the platform until the full assembly is reached.

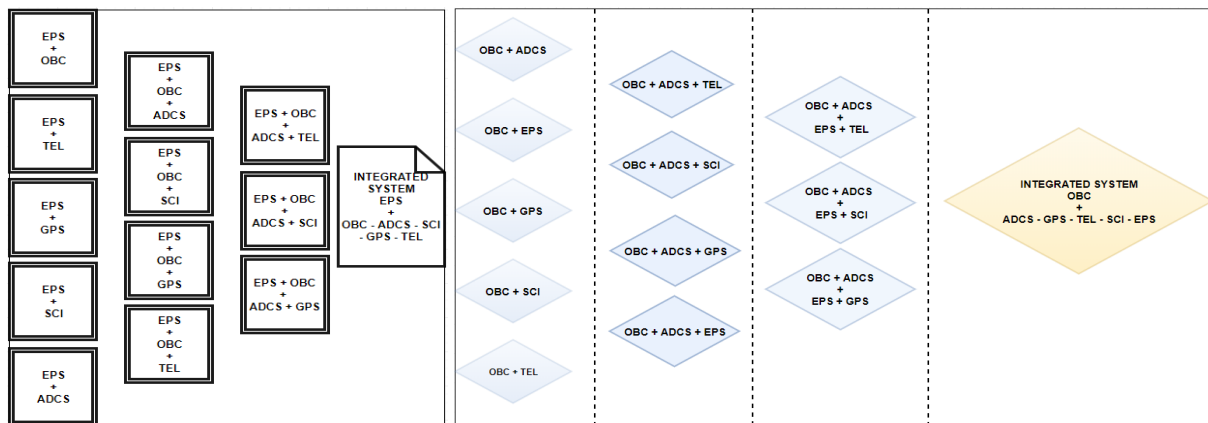

Figure 41. Functional Model Engineering Test for OBC (left) and EPS (right)

The EPS consists of the Alimentation Board, Battery Board, and Solar Panels combined in a closed loop is the main power provider of the entire IGOSat system. In this internship, I gave support for the integration of the solar panel to the EPS.

In the integration, I am working with the Space Mechanical Engineer, we are changing some connectors orientation, defining the part number, etc.

My job in this internship will end with the power budget of the systems.

CONCLUSIONS

Thanks to this internship in Electronics System Engineer Flat-Sat in IGOSat, I can work around the whole satellite system, I like it so much because I like to keep in touch with the whole project and not just a part of this.

To describe documents that can be understood by all team members, they must be in the same language since we do not all come from the same science branches.

It is important to be constantly informed of all payloads, support platforms, and the mechanical part since a change in one subsystem could affect another.

A cross-development environment has the challenge of dependence related to the manufacturer's deadlines and the time that the development takes.

4.1 Recommendations

At the beginning of the internship, it was a little difficult for me to understand the operation, location, and interconnection of each system, so I hope that with this document I can introduce IGOSat issues to the following inmates in an easier way.

4.2 Perspectives

I am very grateful to IGOSat for giving me the opportunity to approach the space sector of which I have always been curious, although in my country we have a good level in science, we cannot agree to be part of projects like this that fulfill great purposes and they consolidate in countries like France that give great importance to research and development.

The work experience I had in my country helped me a lot in this internship, and I discovered

that I have new skills and I hope to continue developing them.

IGOSat has helped me to see beyond and that is why the perspective I have in the future is to take the opportunity of one year VISA that the French government gives me to look for a job or a doctorate here in France related to the space from which I can continue learning and contributing with what I can to research and development in this beautiful field of science.

SOURCES

- [1] Aristotle Space & Aeronautics Team. (n.d.). *ASAT*. Retrieved 08 16, 2019, from <https://asat.gr/2019/02/18/cubesat-meet-the-communications-subsystem/>
- [2] California Polytechnic State University. (2014, 02 20). *CubeSat Design Specification*. Retrieved 08 18, 2019, from https://static1.squarespace.com/static/5418c831e4b0fa4ecac1bacd/t/56e9b62337013b6c063a655a/1458157095454/cds_rev13_final2.pdf
- [3] Consortium, PC/104 Embedded. (2008, 10 13). *PC/104 Specification v2.6*. Retrieved 08 16, 2019, from https://pc104.org/wp-content/uploads/2015/02/PC104_Spec_v2_6.pdf
- [4] DEBES, J. (2011). *Digital Commons*. Retrieved 08 16, 2019, from <https://digitalcommons.usu.edu/cgi/viewcontent.cgi?article=1148&context=smallsat>
- [5] ECE Paris. (n.d.). *ece3sat*. Retrieved 08 16, 2019, from <http://www.ece3sat.com/cubesatmodules/adcs/>
- [6] ESA. (n.d.). *United Space in Europe*. Retrieved 08 16, 2019, from https://www.esa.int/Our_Activities/Space_Engineering_Technology/Onboard_Computer_and_Data_Handling/Onboard_Computers
- [7] HARWIN . (2019). *Harwin Plc*. Retrieved 07 01, 2019, from https://cdn.harwin.com/pdfs/C005XX_M80_and_M83_Datamate_Series_Connectors.pdf
- [8] Humberto, H. (2018). On-Orbit Center Of Mass Relocation System For A 3U Cubesat. www.researchgate.net. Retrieved from https://www.researchgate.net/publication/328227968_On-Orbit_Center_Of_Mass_Relocation_System_For_A_3U_Cubesat

- [9] Ibrahim, T. (2012). DESIGN AND IMPLEMENTATION OF EPS OF A CUBESAT. Khartoum: University of Khartoum.
- [10] ISIS. (n.d.). *ISIS Space*. Retrieved 08 15, 2019, from <https://www.isispace.nl/product/3-unit-cubesat-structure/>
- [11] JANUS; CNES. (2016, 9 9). *Lagrange*. Retrieved 8 15, 2019, from https://lagrange.oca.eu/images/LAGRANGE/seminaires/JANUS_9-9-16.ppt
- [12] NASA. (2017). *CubeSat101 Basic Concepts and Processes for First-Time CubeSat Developers*. Retrieved 8 14, 2019, from https://www.nasa.gov/sites/default/files/atoms/files/nasa_csli_cubesat_101_508.pdf
- [13] NGUYEN, T. D. (2018). *IGOSat CUBESat at Paris Diderot Assembly, Integration and Testing*. Paris: USTH.
- [14] SAMPTEC. (n.d.). *SAMTEC SOLUTIONS*. Retrieved 08 12, 2019, from http://suddendocs.samtec.com/catalog_english/esq_th.pdf